



ROSSINI
1928



Production facilities



 **Rossini S.p.A.
HeadQuarters**

Viale A. De Gasperi, 5
20027 Rescaldina
Milano - Italy
Tel. +39 0331 47 27 11
Fax +39 0331 57 97 46
comm.dept@rossini-spa.it



 **Rossini S.p.A.
L'Aquila**

Comprensorio di Bazzano
67100 L'Aquila
Italy
Tel. +39 0862 44 561
Fax +39 0862 44 15 32
comm.dept@rossini-spa.it



 **Rossini
Spain**

Cami del Mig, 8-10
08349 Cabrera De Mar
Barcelona - Spain
Tel. +34 93 759 60 33
Fax +34 93 759 35 35
rossini@rossinispain.com



 **Rossini India Printing
Rollers Pvt. Ltd.**

Plot. C22/2, MIDC Phase II
Chakan Industrial Area,
410501 Pune
Maharashtra - India
Tel. +91 2135 62 7800
info@rossini-india.com



 **Rossini
Equipment**

Via Galileo Galilei, 99/115
21040 Uboldo
Varese - Italy
Tel. +39 0331 47 27 11
Fax +39 0331 57 97 46
comm.dept@rossini-spa.it



 **Rossini North
America, LLC**

Creek Park Drive
4305 30024 3996
Atlanta - Georgia - USA
Tel. +1 (678) 482 0835
Fax +1 (678) 482 0837
customer-service@rossini-na.com



 **Rossini Sleeve
Technologies**

Chisoda D.N.59, Km 8+550
M Conform C.F., 307221 Chisoda
Timisoara - Romania
Tel. +40 356 45 68 94
Fax +40 356 45 81 96
info@rossini-romania.ro

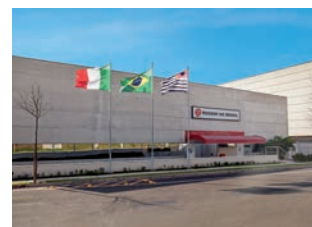

 **Rossini
Do Brasil**

Rod. Anhanguera, Km 33 Jardim
Jordanésia - 07750-000
Cajamar - SP - Brazil
Tel. +55 11 444 647 74
Fax +55 11 444 647 74 117
info@rossini-brasil.com.br

Sales offices

 **Rossini
UK Ltd.**

Breach, Clutton
BS39 5QR - Bristol
England
Tel. +44 1761 45 38 83
Fax +44 1761 45 38 83
rossinisleeves@btconnect.com

 **Rossini
France**

B.P. 23
68720 Illfurth
France
Tel. +33 03 893 191 20
Fax +33 03 890 641 54
contact@rossinifrance.fr

 **Rossini
GmbH**

Toni Bauer Strasse, 8
53894 Mechemich
Germany
Tel. +49 2443 31 47 59
Fax +49 2443 90 23 48
info@rossini-germany.com



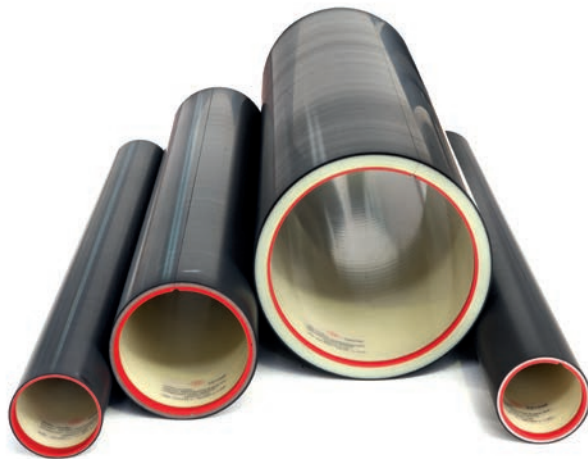

C'è un solo modo per garantire il massimo della qualità: puntare sempre alla perfezione. È questa la filosofia che ha fatto della Rossini Spa un'azienda leader nel mondo nella progettazione e produzione di rulli e maniche porta matrici per la stampa flessografica, rotocalco e offset.

Prodotti d'eccellenza e un servizio al top: sempre vicini al Cliente, tempestivi nell'assistenza, per offrire ogni giorno una qualità superiore.

qualità superiore dal 1928 *superior quality since 1928*

There is only one way to ensure the best possible quality: always strive for perfection. This is the philosophy that has made Rossini Spa a leader in the design and manufacture of rollers and plate holder sleeves for flexo printing, gravure, offset printing, and laminating-coupling-coating machines.

Outstanding products combined with first-class service: we are always on hand for the customer, offering rapid service to ensure superior quality every day.

Nel dipartimento Ricerca e Sviluppo della Rossini Spa sono nate alcune fra le più importanti innovazioni che hanno rivoluzionato il mondo della stampa flessografica, rotocalco e offset.

Soluzioni, sempre all'avanguardia, mirate a migliorare l'efficienza delle prestazioni, a incrementare la produttività e a rendere sempre più sicura ed efficace l'attività lungo l'intero processo.

Idee e prodotti innovativi tanto da conseguire una serie straordinaria di brevetti internazionali, sviluppati totalmente in azienda.



il valore più autentico della ricerca *research worthy of the name*

Over the years, the Research and Development department of Rossini Spa has developed some of the most important innovations that have revolutionized the world of flexographic, rotogravure and offset printing.

Cutting-edge solutions designed to improve performance efficiency, increase productivity and make the entire process safer and more effective.

Ideas and innovative products that have led to an extraordinary array of international patents, developed entirely in-house.

Centro Ricerche e Sviluppo dello stabilimento Rossini Spain, Cabrera de Mar, Barcelona. Nella pagina precedente: **Dinamometro Zwick 250kN** per prove di resistenza a trazione e compressione sui materiali.

*Research and Development Centre of the facility Rossini Spain, Cabrera de Mar, Barcelona. In the previous page: **Zwick 250KN Dynamometer** for traction and compression test on materials.*

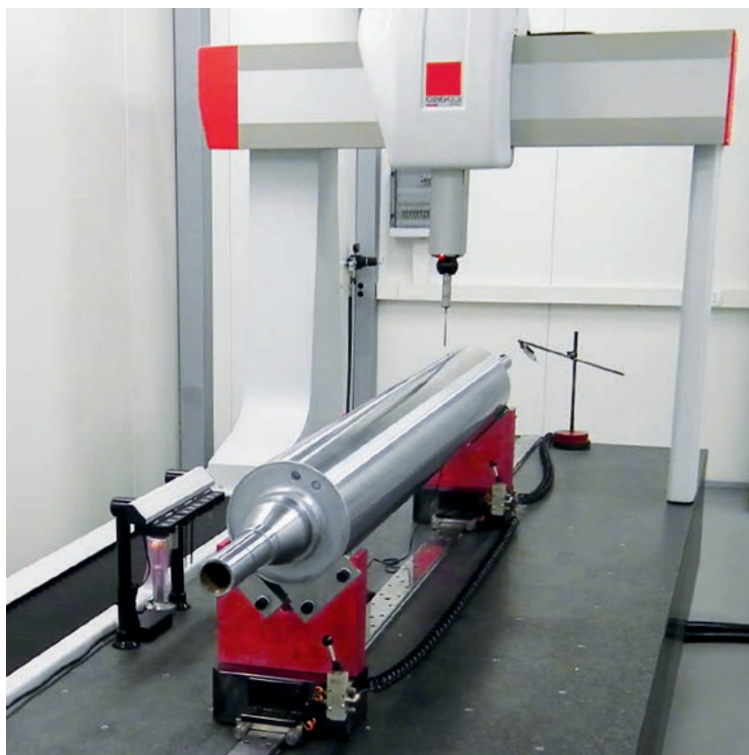

Macchina per controllo 3D specifica per analisi dimensionale su rulli e mandrini installata in Rossini Spain e Rossini Italy.

3D Control machine customized for dimensional check of rollers and mandrels installed in Rossini Spain and Rossini Italy.



tecnologia della gomma *rubber technology*

Rossini ha due linee di produzione specifiche per la realizzazione di mescole in gomma: una riservata al nero e l'altra per le mescole colorate. In Rossini la qualità è sempre al primo posto per questo ogni mescola viene finemente filtrata per evitare impurità nel rivestimento finale e campionata per rilevare i parametri tecnici di riferimento prima della successiva lavorazione. L'intero processo produttivo prevede una totale tracciabilità dei materiali in ogni fase di lavorazione. Rossini produce gomme classiche, mescole certificate per alimenti oltre all'innovativa ESA RED certificata ATEX.

Rossini has two dedicated production lines for rubber compound: one reserved for the black and the other one for the colored compound. In Rossini quality is always at the top and for this reason each compound is finely filtered to avoid clusters or defects on the final coating and samples are taken for technical parameter cross-control before the coating. The whole production process grants a complete material traceability in the different production phases. Rossini produces classic rubbers, compounds certified for food contact and above all the ESA RED ATEX certified.

Reparto produzione
mescole gomma.

*Rubber compounds
production department.*



flessografia
flexography



RUBBER COVERED SLEEVE

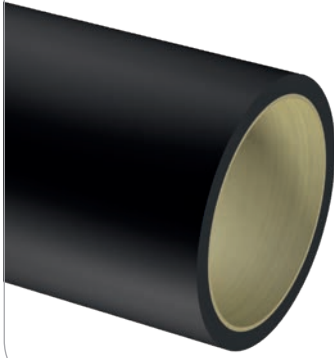

Photoflex Stat

Sleeve con base in fibra di vetro conduttiva rivestita da speciale polimero antistatico resistente ad acetato d'etile, alcool e MEK. La superficie viene lavorata con perfetta finitura per utilizzo nella stampa in continuo di fondi pieni, laccatura e incisione laser.

Conductive fibreglass base sleeve coated in special, antistatic polymer resistant to ethyl acetate, alcohol and MEK. The surface is perfectly finished for use in continuous flood-coating printing, varnishing and laser engraving.



hardness range 60-85



antistatic sleeve



PTB Norm compliant



HD print level



more productivity

PLATE SLEEVES

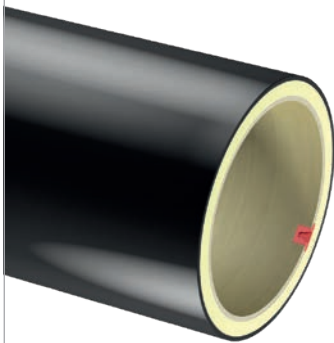

Everstat Light

Manica conduttiva per lastre [$< 1 \text{ MOhm}$] con elevata stabilità nella stampa e peso ridotto, grazie alla schiuma in PU a bassa densità utilizzata come materiale di riempimento. La schiuma PU idrofoba impedisce inoltre alle maniche di assorbire umidità sui lati e garantisce precise tolleranze di diametro. Lo strato superiore di poliuretano duro offre ottime caratteristiche in combinazione nastri biadesivi comprimibili. **La scelta premium dei nostri clienti OEM per le maniche porta lastra! Disponibile con cava in PU o con anello opzionale in PU.**

*Conductive plate sleeve [$< 1 \text{ MOhm}$] with high stability in printing and reduced weight, thanks to the low-density PU foam used as filling material. The hydrophobic PU foam also prevents the sleeves from absorbing humidity on the sides and assures precise diameter tolerances. The top layer of hard polyurethane provides very good characteristics in combination with cushion-back tapes. **The premium choice of our OEM customers for plate sleeves! Available with PU slots or with optional PU ring.***



hardness 75 ShD



antistatic sleeve



PTB Norm compliant



HD print level



high longevity



humidity resistant



mechanical resistance



Evergreen Light

Sleeve porta lastra per utilizzo con biadesivi ammortizzanti. La speciale formulazione in PU Evergreen dello strato esterno la rende indicata per applicazioni di stampa flessografica sia con inchiostri a base acqua che a base solvente. **Disponibile con cava in PU o con anello opzionale in PU.**

*Plate holder sleeve for use with double-sided adhesive cushion tapes. The special formulation in PU Evergreen of the outer layer makes it ideal for flexographic printing applications with water based and solvent based inks. **Available with PU slots or with optional PU ring.***



hardness 75 ShD



HD print level



high longevity



mechanical resistance

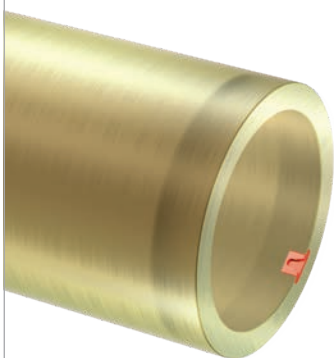

Everglass Light

Sleeve porta lastra per utilizzo con biadesivi ammortizzanti. La fibra di vetro sulla superficie esterna e laterale garantisce buona resistenza meccanica, una completa resistenza a tutti i solventi e alta stabilità dimensionale. **Disponibile con cava in PU o con anello opzionale in PU.**

*Plate holder sleeve for use with double-sided adhesive cushion tapes. The fibreglass on the outer side surface guarantees good mechanical strength, complete resistance against all solvents and dimensional stability. **Available with PU slots or with optional PU ring.***



hardness 80 ShD



HD print level



high longevity



mechanical resistance



solvent resistant



humidity resistant

PLATE SLEEVES

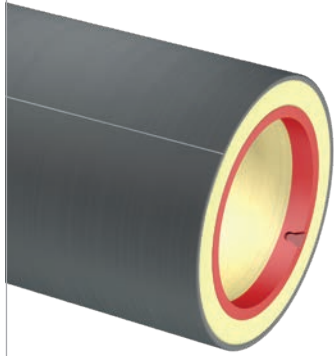

Everglass Stat Light

Sleeve porta lastra per utilizzo con biadesivi ammortizzanti. Everglass Stat Light è rivestita sulla superficie esterna in speciale fibra di vetro e carbonio con dispersione della carica statica ottenuta mediante l'utilizzo di fibre di carbonio, e non attraverso la verniciatura della superficie, garantendo valore di resistività inferiore a 1 [MΩ]. **Sleeve porta lastra unica che fornisce numerosi vantaggi:**

- Elevata rigidità strutturale e lunga durata grazie alla particolare costruzione
- Ottima resistenza a umidità e solventi di normale impiego nella stampa flessografica
- Totale stabilità dimensionale e altissima resistenza meccanica
- Specifica per stampa in Alta Definizione e d'immagini multiple

Disponibile con opzione cava o con anello.



hardness
80 ShD



antistatic
sleeve



HD print
level



high
longevity



solvent
resistant



humidity
resistant



mechanical
resistance

*Plate mounting sleeve for use with double-sided adhesive. Everglass Stat Light has a conductive outer surface with a special fibreglass and carbon fibres mix. It disperses the static charge through the use of carbon fibres and not through a conductive surface paint. Everglass Stat Light has a guaranteed resistance value less than 1 [MΩ]. **This plate mounting sleeve has numerous advantages:***

- High structural rigidity and long life thanks to the particular construction
- Excellent resistance to humidity and solvents commonly used in flexographic printing
- Total dimensional stability and very high mechanical resistance
- Specification for High Definition and multiple image printing

Available with Notch or protection ring.

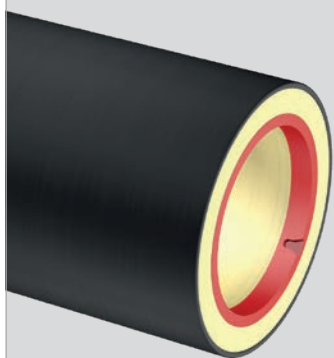

Starcoat Light

Sleeve porta lastra antistatica per utilizzo con biadesivi ammortizzanti. Starcoat è rivestita sulla superficie esterna in speciale poliuretano antistatico con dispersione della carica statica ottenuta mediante l'utilizzo di fibre di carbonio, e non attraverso la verniciatura della superficie, garantendo valore di resistività inferiore a 1 [MΩ]. **Sleeve porta lastra unica che fornisce numerosi vantaggi:**

- Elevata rigidità strutturale e lunga durata grazie alla particolare costruzione
- Specifica per stampa in Alta Definizione e d'immagini multiple
- Eccellente resistenza a umidità e solventi
- Totale stabilità dimensionale e altissima resistenza meccanica

*Antistatic plate sleeve for use with cushioning double-sided adhesive tapes. The outer surface of Starcoat is coated in a special antistatic polyurethane with dissipation of the static charge obtained through the use of carbon fibre, and not by surface painting, ensuring resistivity values below 1 [MΩ]. **This plate mounting sleeve has numerous advantages:***

- High structural rigidity and long life thanks to its special construction
- Created specifically for High Definition and multiple image printing
- Excellent resistance to moisture and solvents
- Absolute dimensional stability and superlative mechanical strength



hardness
75 ShD



antistatic
sleeve



HD print
level



high
longevity



humidity
resistant



mechanical
resistance



Protection
ring version



Thin A

Sleeve porta lastra per utilizzo con biadesivi ammortizzanti. Costruita in fibra di vetro è utilizzata per la stampa del primo sviluppo (su mandrino macchina e/o su carrier Rossini) inoltre può essere utilizzata per lo stoccaggio di stampe ripetitive vista la sua economicità.

Plate mounting sleeve for use with double-sided adhesive cushion tapes. Made of fibreglass for first printing repeat (on a press mandrel and/or Rossini carrier). Furthermore, it can be used for storage of repetitive prints thanks to its competitive price.



hardness
90 ShD



high
longevity



solvent
resistant



humidity
resistant

LABEL & NARROW WEB

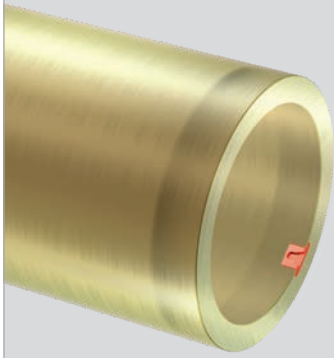

Everglass Light

Sleeve porta lastra per utilizzo con biadesivi ammortizzanti. La fibra di vetro sulla superficie esterna e laterale garantisce buona resistenza meccanica, una completa resistenza a tutti i solventi e alta stabilità dimensionale. **Ideale per stampa "Etichette" e "Narrow Web". Disponibile con cava in PU o con anello opzionale in PU.**

*Plate holder sleeve for use with double-sided adhesive cushion tapes. The fibreglass on the outer side surface guarantees good mechanical strength, complete resistance against all solvents and dimensional stability. **Especially designed for "Label" and "Narrow Web" printing field. Available with PU slots or with optional PU ring.***



hardness
80 ShD



HD print
level



high
longevity



mechanical
resistance



solvent
resistant



humidity
resistant

ANILOX

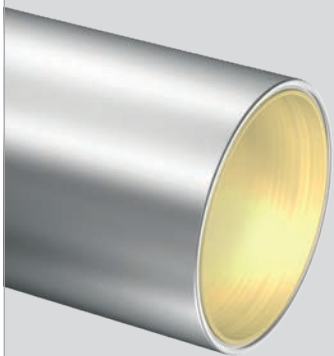

Air Anilox

Fornito ai principali produttori mondiali di anilox sleeves; Rossini ha sviluppato una speciale sleeve di base in vetroresina studiata per garantire stabilità dimensionale al successivo processo di assemblaggio del tubo di alluminio, al processo finale di rivestimento ceramico e incisione eseguito dai nostri clienti. Ogni tubo di alluminio viene pre-lavorato su una speciale macchina barenatrice ottenendo valori di eccentricità estremamente bassi prima dell'assemblaggio; ogni sleeve viene poi bilanciata dinamicamente come da specifiche. La superficie esterna del tubo di alluminio è finita con tornitura ad altissima velocità e precisione per ottenere perfetta uniformità e un valore di rugosità idoneo per la deposizione tramite plasma coating (o simile) dello strato ceramico poi inciso. Lavorazioni meccaniche eseguite con le ultime tecnologie, materiali disponibili a magazzino, un processo produttivo certificato e tempi di consegna ridotti permettono all'Air Anilox di Rossini di imporsi come la miglior scelta sul mercato per i produttori di anilox sleeves.

Supplied to the main worldwide manufacturer of anilox sleeves; Rossini has developed a special glass fiber base sleeve designed to grant dimensional stability to the following assembly of the aluminum tube, to the final process of ceramic coating and engraving made by our customers.

Each aluminum tube is pre-worked on a special boring machine with very low final eccentricity before the assembly; every sleeve is dynamically balanced according specs.

The external surface of the aluminum tube is polished with very high speed and precise lathing machines to grant total uniformity and ideal roughness for the following ceramic plasma coating (or similar process) and engraving. Up-to-date mechanical processing, raw materials from stock, a certified production process and short delivery time rise up Air Anilox Rossini as the best choice for the anilox sleeves manufacturers.



high
longevity



humidity
resistant



manual
handling



mechanical
resistance



more
productivity



quality
certified



ANILOX

Anilox Cover

Sleeve in PU elastico realizzata per proteggere gli anilox riposti a magazzino da urti e polvere. Lo speciale design con interno conico e maniglia esterna permette un posizionamento agevolato senza uso di aria o altri strumenti meccanici. È l'unico prodotto di protezione sul mercato che permette di montare in macchina l'anilox completo della sua protezione che verrà rimossa soltanto quando l'anilox è in posizione di stampa prevenendo in tal modo qualsiasi danneggiamento da urto durante il montaggio.

Elastic PU sleeve designed for anilox protection against mechanical damages and powder when stored. The special tapered shape and an external handle allows an easy fitting on the anilox without the use of air or other mechanical tools. It is the only protection device that allows to mount on press the anilox covered with its protection that will be removed only when anilox is fixed in printing position, preventing in this way any accidental damage during mounting operation.



hardness
range 86-90



high
longevity



manual
handling



mechanical
resistance



solvent
resistant

CARRIER

Carrier (Brevetto / Patent n.1275901)

Adattatore pneumatico antistatico per riduzione spessore delle sleeves porta lastra. Riducendo i pesi agevola la movimentazione dei carichi con notevole risparmio di tempo nella preparazione della macchina (job change). Disponibile nelle versioni **Side Air** e **Fori Passanti**.

*Antistatic Pneumatic adapter to reduce plate mounting sleeve thickness. It enables an important reduction in weights facilitating the manual handling of the loads with considerable savings over time in machine preparation (job change). Available: **Side Air** or **Flow Through** technology.*

Struttura

Struttura interna in fibra di vetro con strato comprimibile. Supporto esterno: tubo leggero in fibra di carbonio. Flange laterali in alluminio garantiscono totale resistenza alla penetrazione di umidità e solventi. Anello di protezione in acciaio con cava di registro integrata.

Structure

Fibreglass base sleeve with compressible layer. External support: light carbon fibre tube. The aluminium side flanges guarantee total resistance against humidity and solvent penetration. Steel protection ring with integrated notch.

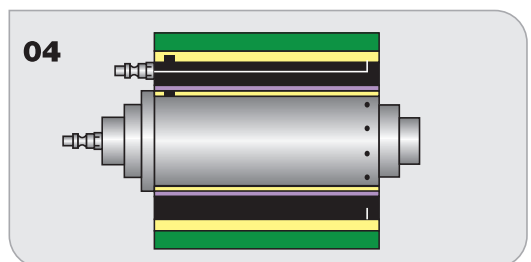
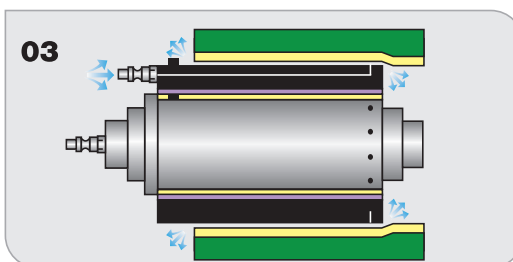
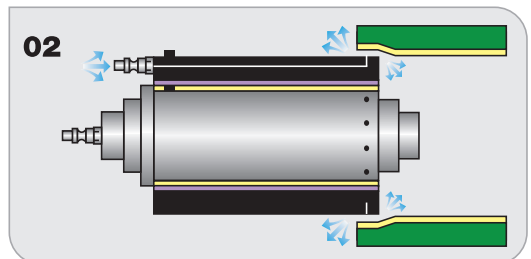
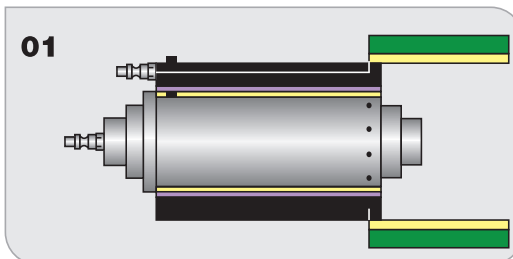
Sequenza montaggio sleeve / Sleeve assembly sequence

hardness
90 ShD



humidity
resistant



protection
ring



mechanical
resistance



solvent
resistant



antistatic
sleeve

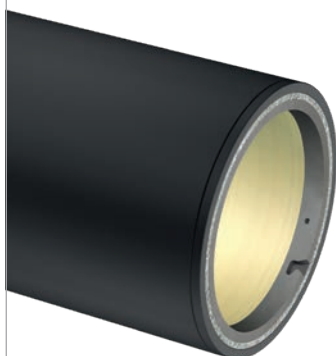

PTB Norm
compliant

CARRIER**Cushion Bridge**

Carrier pneumatico in fibra di carbonio ad alto modulo con superficie esterna comprimibile a due livelli progettato con un'ottimale distribuzione del flusso di aria compressa per il montaggio ed utilizzo di sleeves cilindriche incise gapless in fotopolimero. La capacità di smorzamento delle vibrazioni di stampa e l'alta rigidità del tubo in fibra di carbonio permettono il raggiungimento di una superiore velocità di produzione. Cushion Bridge è fornibile sia in configurazione **Side Air** che **Fori Passanti**.

Struttura

Struttura interna in fibra di vetro. Supporto esterno: tubo in fibra di carbonio alto modulo (HM). Flange laterali in alluminio per una totale resistenza alla penetrazione d'umidità e solventi. La sezione comprimibile è composta da un primo strato di base in speciale poliuretano a celle aperte con altissima elasticità e un secondo strato esterno a celle chiuse che garantiscono una perfetto rebound per stampa con ottimi risultati sia a fondo pieno che con gradazioni di colore.

*High modulus carbon fiber pneumatic Carrier with double layer compressible external surface designed with a special distribution of the compressed air flow for mounting endless photopolymer engraved sleeves. The printing vibration damping and the high stiffness of the high modulus carbon fiber tube allow a superior production speed. Cushion Bridge can be supplied both in **Side Air** and **Flow Through** configuration.*

Structure

Fibreglass base sleeve. Outer support: high module (HM) carbon fibre tube. The aluminium side flanges guarantee total resistance against humidity and solvent penetration. The compressible area is made by a first base layer in special urethane with open cells and a second top layer with closed cells that guarantee a perfect rebound with top printing results both with full tone and color grade.



HD print level



high longevity



humidity resistant



manual handling



mechanical resistance



more productivity



protection ring

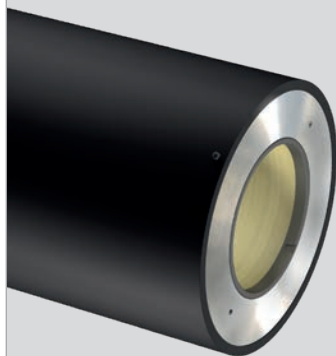

quality certified

HIGH MODULUS CARRIER**FastBridge® HM**

Adattatore pneumatico specificatamente studiato per assorbire le vibrazioni delle battute in stampa sia a media che ad alta velocità grazie all'utilizzo di fibre di carbonio ad altissimo modulo stese con opportune inclinazioni determinate dall'ufficio R&D Rossini. **Collaudato in fase di stampa fino a 800 [m/min] garantisce un aumento della velocità di produzione del 30%. È una alternativa al Carrier idraulico ma con prestazioni superiori.**

Antistatico, è compatibile con tutte le sleeves porta lastra Rossini. Inoltre, consente un'importante riduzione dei pesi delle sleeves agevolando la movimentazione manuale dei carichi con notevole risparmio di tempo nella preparazione della macchina (job change). FastBridge è disponibile sia nella configurazione **Side Air** che **Fori Passanti**.

Struttura

Struttura interna in fibra di vetro. Tubo esterno in fibra di carbonio altissimo modulo (HM). Flange laterali in alluminio per una totale resistenza alla penetrazione d'umidità e solventi. Cava di registro integrata nell'anello di protezione in acciaio montato sulla flangia.

*Pneumatic adapter engineered to perform a consistent absorption of print vibrations at different production speeds thanks to the application of very high modulus carbon fibers layed at specific angles newly defined by the R&D department of Rossini. **Comprehensively tested for print speeds up to 800 [m/min], FastBridge adapters provide an average print speed gain of at least 30%, especially on vibration prone print jobs. Outstanding performance, ease of handling and maintenance free operation make it a superior alternative to hydraulic adapters.***

*It is antistatic and can be used with all Rossini plate sleeves. This special High Modulus Carbon fiber adapter reduces vibration and enhances printing quality, allowing to achieve considerably higher production speeds. FastBridge is available both **Side Air** and **Flow Through** configuration.*

Structure

Fibreglass base sleeve. Outer tube in high module (HM) carbon fibre. The aluminium side flanges guarantee total resistance against humidity and solvent penetration. Register notch built into the protective steel ring mounted on the flange.



HD print level



hardness 75 ShD



humidity resistant



manual handling



mechanical resistance



PTB Norm compliant



protection ring



antistatic sleeve

HIGH MODULUS CARRIER

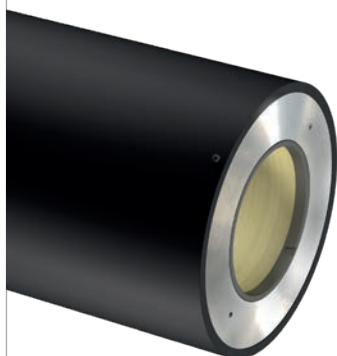
**Carbobridge HM** (Brevetto / Patent n. 1275901)

Adattatore pneumatico antistatico per riduzione spessore delle sleeves porta lastra.

Consente un'importante riduzione dei pesi agevolando la movimentazione manuale dei carichi con notevole risparmio di tempo nella preparazione della macchina (job change).

Costruito in fibra di carbonio ad Alto Modulo, ha flessioni inferiori all'acciaio, riduce le vibrazioni e valorizza la qualità delle stampe nelle produzioni ad alta velocità.

Compatibile con tutte le sleeves porta lastra Rossini.

Disponibile nelle versioni:

Standard e **Fori Passanti**.

Struttura

Struttura interna in fibra di vetro. Supporto esterno: tubo in fibra di carbonio alto modulo (HM).

Flange laterali in alluminio per una totale resistenza alla penetrazione d'umidità e solventi.

Pneumatic adapter to reduce plate mounting sleeve thickness.

It enables an important reduction in weights facilitating the manual handling of the loads with considerable savings over time in machine preparation (job change).

Made in HM (high modulus) carbon fibre, it has lower mechanical deflections when compared to the steel, it reduces the vibrations and gives an added value to the printing quality at high speed.

Compatible with all Rossini plate holder sleeves.

Available in versions:

Standard or **Flow Through** technology.

Structure

*Fibreglass base sleeve. Outer support in high module (HM) carbon fibre tube. **The aluminium side flanges** guarantee total resistance against humidity and solvent penetration.*



HD print level



hardness 75 ShD



humidity resistant



manual handling



mechanical resistance



PTB Norm compliant



protection ring



antistatic sleeve

**Carbobridge HM** (Brevetto / Patent n. 1275901)

Adattatore pneumatico antistatico per riduzione spessore delle sleeves porta lastra.

Consente un'importante riduzione dei pesi agevolando la movimentazione manuale dei carichi con notevole risparmio di tempo nella preparazione della macchina (job change).

Costruito in fibra di carbonio ad Alto Modulo, ha flessioni inferiori all'acciaio, riduce le vibrazioni e valorizza la qualità delle stampe nelle produzioni ad alta velocità.

Compatibile con tutte le sleeves porta lastra Rossini.

Disponibile nelle versioni:

Standard e **Fori Passanti**.

Struttura

Struttura interna in fibra di vetro. Supporto esterno: tubo in fibra di carbonio alto modulo (HM).

Flange laterali in carbonio per una totale resistenza alla penetrazione d'umidità e solventi.

Pneumatic adapter to reduce plate mounting sleeve thickness.

It enables an important reduction in weights facilitating the manual handling of the loads with considerable savings over time in machine preparation (job change).

Made in HM (high modulus) carbon fibre, it has lower mechanical deflections when compared to the steel, it reduces the vibrations and gives an added value to the printing quality at high speed.

Compatible with all Rossini plate holder sleeves.

Available in versions:

Standard or **Flow Through** technology.

Structure

*Fibreglass base sleeve. Outer support in high module (HM) carbon fibre tube. **The carbon fibre side flanges** guarantee total resistance against humidity and solvent penetration.*



HD print level



hardness 75 ShD



humidity resistant



manual handling



mechanical resistance



PTB Norm compliant



protection ring



antistatic sleeve

SPEEDWELL Sleeves System

Nel 1976 Rossini realizza e brevetta Speedwell, primo e unico sistema per il cambio rapido del rivestimento del pressore gommato senza rimozione del rullo dalla macchina rotocalco.

La soluzione innovativa che permette veloci cambi lavoro, evita lunghi fermi-macchina dovuti alla sostituzione del cilindro pressore d'acciaio gommato, migliorando l'efficienza delle prestazioni garantendo più sicurezza e condizioni di lavoro ottimali agli operatori.

L'innovativo brevetto internazionale è adottato dai maggiori produttori di macchine da stampa rotocalco e conta a oggi oltre 3.000 installazioni che riportano nel manuale tecnico la specifica "macchina con sistema Rossini".

L'ufficio tecnico Rossini è a disposizione per progettare e realizzare il vostro mandrino in funzione delle caratteristiche richieste.

In 1976 Rossini design and patent Speedwell the first and unique system for quick change of the pressure roller rubber coating without removal of the cylinder from the rotogravure machine.

The innovative solution the allows fast job change, avoids long machine downtime for rubber pressure roller change, improving the efficiency, grating more safety and better working condicions for the printers.



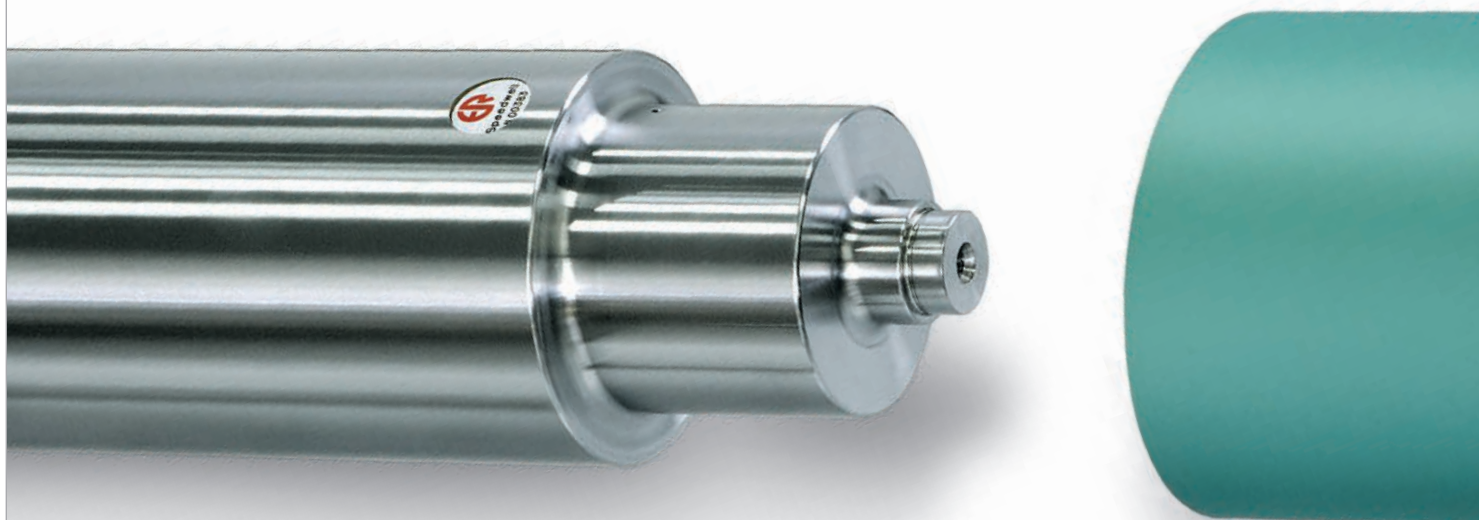

This international patent was adopted by the main rotogravure printing manufacturers and more than 3,000 installations have in the technical manual the specification "machine with Rossini's system".

Rossini's technical office is available to design and manufacture your mandrel coupon your technical requests.



Colour Hardness

Codici colori applicati ai differenti modelli di sleeve identificano i corrispondenti gradi di durezza.
Colour codes applied to different sleeve models identify corresponding hardness levels.

| | | | | |
|---|---|---|---|---|
| Giallo Yellow | Blu Blue | Rosso Red | Verde Green | Bianco + colore durezza White + hardness color |
|  |  |  |  |  |
| 70-74 shore A | 75-79 shore A | 80-84 shore A | 85-90 shore A | E.S.A. system |



rotocalco
rotogravure



SPEEDWELL SLEEVES AND RUBBER IMPRESSION ROLLERS

Neopress G Stat

Elastomero specifico per rivestimento rulli pressori in stampa rotocalco in presenza di inchiostri a base solventi acetati, alcoli, MEK e max 20% toluene. La sleeve di base in fibra di vetro conduttiva e la speciale miscela rendono il prodotto antistatico. Pulizia con 100% acetato d'etile.

Special elastomer for coating rubber impression rollers in rotogravure printing in presence of inks with acetate solvents base, alcohol, MEK and max 20% toluene. The fiber glass conductive sleeve and the special compound make the product antistatic. Cleaning with 100% ethyl acetate.



hardness range 50-90



max load 25 [kg/cm]



max temp 140 °C



antistatic sleeve



speedwell sleeve



food contact certified

Neopress C Stat

Elastomero specifico per rivestimento rulli pressori in stampa rotocalco in presenza d'inchiostri a base acqua o alcool. La sleeve di base in fibra di vetro conduttiva e la speciale miscela rendono il prodotto antistatico. Pulizia con miscela di 80% alcool etilico e 20% acetato d'etile.

Special elastomer for coating rubber impression rollers in rotogravure printing in presence of water or alcohol based inks. The fiber glass conductive sleeve and the special compound make the product antistatic. Cleaning with a blend of 80% ethyl alcohol and 20% ethyl acetate.



hardness range 60-90



max load 40 [kg/cm]



max temp 90 °C



antistatic sleeve



speedwell sleeve



food contact certified

Neopress B-BH Red

Elastomero specifico per rivestimento rulli pressori con inchiostri a solventi alifatici e alte pressioni di stampa (fino a 50 [kg/cm]) su carta, cartoncino, materiali accoppiati e alluminio. Resiste alle incisioni del bordo del materiale. Pulizia con benzine oppure con miscela di 100% alcool etilico.

Special elastomer for coating rubber impression rollers with aliphatic solvents based inks and high printing pressure (up to 50 [kg/cm]) on paper, cardboard, laminated substrates and aluminum; highly resistant to the edge cuts. Cleaning with gasoline or with a blend of 100% ethyl alcohol.



hardness range 60-95



max load 50 [kg/cm]



max temp 120 °C



antistatic sleeve



speedwell sleeve



food contact certified

Neopress PU - Neopress PU Stat

Tecnopolimero formulato per rivestimento rulli pressori nella stampa carta e cartoncino con inchiostri a base acqua o alcool e alte pressioni. Resiste alle incisioni del bordo del materiale. Disponibile anche antistatico. Pulizia con benzine oppure con miscela di 80% alcool etilico e 20% acetato d'etile.

Technopolymer designed to coat printing impression rollers for paper and cardboard with water or alcohol based inks and high pressures; highly resistant to the edge cuts. Available also in antistatic construction. Cleaning with gasoline or with a blend of 80% ethyl alcohol and 20% ethyl acetate.



max load 40 [kg/cm]



max temp 90 °C



antistatic sleeve



speedwell sleeve



Neopress PU
hardness range 50-95



Neopress PU Stat
hardness range 70-95

Viton

Rivestimento fluoro-elastomerico con resistenza al contatto di solventi aromatici (100% resistente a toluene e xilolo) caratterizzato da elevata resistenza fino alla temperatura di 200 °C e ai carichi meccanici. Pulizia con benzine oppure con miscela di 100% alcool etilico.

Fluoro-elastomer coating resistant against contact with aromatic solvents (100% resistant against toluene and xylene) characterized by an high resistance to the temperature up to 200 °C and to mechanical loads. Cleaning with gasoline or with a blend of 100% ethyl alcohol.



max load 25 [kg/cm]



max temp 200 °C



speedwell sleeve

Tutte le speciali mescole Rossini sono disponibili sia nella configurazione Speedwell Sleeve che rullo gommatto.
All the special Rossini compounds are available both in Speedwell Sleeve configuration and rubber roller.

ESA PRINTING

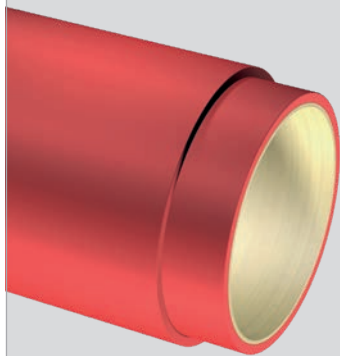
**EsaRed**

Unico elastomero antideflagrante al mondo, certificato Atex

Elastomero ideato per rivestimento rulli pressori con assistenza elettrostatica (ESA) per stampa su film plastico e carta.

EsaRed elimina l'effetto ionizzante tipico delle gomme nere contenenti carbon black.

Unico prodotto certificato in conformità con la normativa ATEX Ex II 2G IIA T4 per l'impiego in Zona 1 rilasciata come elastomero non infiammabile.

I valori di resistenza volumetrica, di superficie e d'isolamento di EsaRed vengono forniti in conformità al sistema di assistenza elettrostatica installata sulla macchina da stampa e alla tipologia di applicazione (Direct Charge, Top Loading e/o Side-Loading).

Per stampa con inchiostro a base solvente, acetato, alcool, MEK e max 20% toluene.

Pulizia con miscela di 75% alcool etilico e 25% acetato d'etile.

The only Atex certified, explosion-proof elastomer in the world

Elastomer designed for printing impression rollers with electrostatic assist (ESA) for printing on plastic film and paper.

EsaRed eliminates the ionization effect typical of traditional black rubber compounds with carbon black.

The only product certified in compliance with the ATEX Ex II 2G IIA T4 standard for use in Zone 1 issued as a non-flammable elastomer.

The volumetric resistance, dynamic resistance and insulation values of EsaRed comply with the electrostatic assist system installed on the printing press and the type of application (Direct Charge, Top Loading and/or Side-Loading).

For printing with solvent-based ink, acetate, alcohol, MEK and max 20% toluene.

Cleaning with a blend of 75% ethyl alcohol and 25% ethyl acetate.



E.S.A. System



hardness range 75-90



max load 15 [kg/cm]



max temp 150 °C



speedwell sleeve

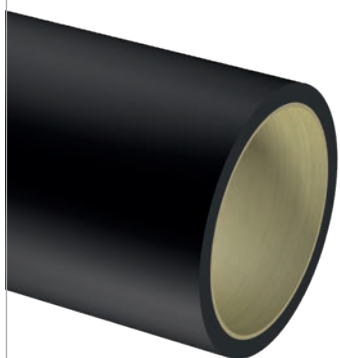

ATEX certified

**Esa Rubber H - Formula 1**

Elastomero ideato per rivestimento rulli pressori per stampa ESA con necessità di carico di stampa più elevato e inchiostri a base solvente. La gomma si differenzia per una ulteriore miglior resistenza all'abrasione. Pulizia con miscela di 75% alcool etilico e 25% acetato d'etile.

Elastomer to coat printing impression rollers with ESA system with higher printing load and solvent based inks.

Performs a further better resistance to the abrasion. Cleaning with a blend of 75% ethyl alcohol and 25% ethyl acetate.



E.S.A. System



hardness range 65-90



max load 20 [kg/cm]



max temp 150 °C

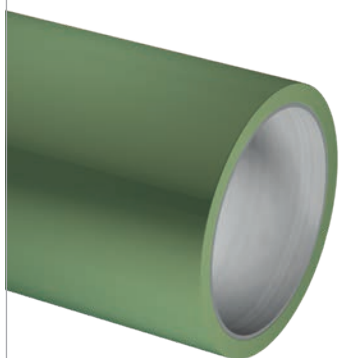

speedwell sleeve

**Green ESA PU**

Tecnopolimero per il rivestimento di rulli pressori stampa ESA su carta e cartoncino con alte pressioni di stampa e alta resistenza all'abrasione con inchiostri a base acqua, alcool o acetato max 30%. Pulizia con benzine oppure con miscela di 80% alcool etilico e 20% acetato d'etile.

Technopolymer designed to coat impression rollers for ESA printing on paper and cardboard with higher printing loads and high resistance to the abrasion with water, alcohol or acetate max 30% based inks. Cleaning with gasoline or with a blend of 80% ethyl alcohol and 20% ethyl acetate.



E.S.A. System



hardness range 80-90



max load 50 [kg/cm]



max temp 90 °C



speedwell sleeve

Tutte le speciali mescole Rossini sono disponibili sia nella configurazione Speedwell Sleeve che rullo gommato.
All the special Rossini compounds are available both in Speedwell Sleeve configuration and rubber roller.

ROLLERS FOR SPECIAL APPLICATIONS



Roto Flow Inking Roller

Rullo di trasferimento inchiostro inciso a laser a buccia d'arancia o a celle quadrate. Mescola caratterizzata da alta resistenza ad acetato, alcoli, MEK e fino al 20% di toluene. Pulizia con 100% acetato d'etile.

Ink transfer roller laser engraved (orange peel or square cells). High resistance against acetate, alcohol, MEK and max 20% toluene. Cleaning with 100% ethyl acetate.

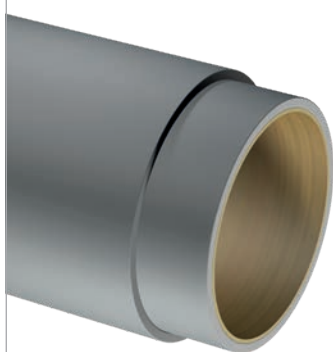

Idropol

Elastomero per rivestimento rulli inchiostriatori per macchine Schlotter. Ideale per stampa cartone ondulato e applicazioni dove è richiesta resistenza chimica a olii, benzene e alcool. Pulizia con benzine oppure con miscela di 80% alcool etilico e 20% acetato d'etile.

Elastomer used to coat ink rollers for Schlotter presses. Ideal for printing on corrugated cardboard and applications where chemical resistance against oils, benzene and alcohol is required. Cleaning with gasoline or with a blend of 80% ethyl alcohol and 20% ethyl acetate.

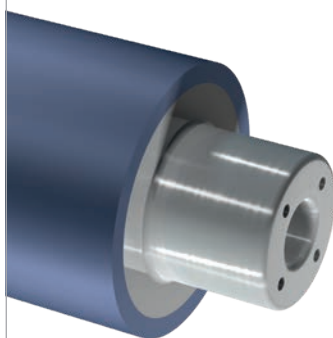

Idrolast

Elastomero ad altissima elasticità utilizzato per rulli di traino e/o di pressione per applicazioni speciali. Disponibile in durezza da 30 a 40 Shore A. Pulizia con benzine oppure con miscela di 80% alcool etilico e 20% acetato d'etile.

High elastic polymer used for drive rollers and/or pressure rollers for special applications. Available in 30 to 40 hardness Shore A. Cleaning with gasoline or with a blend of 80% ethyl alcohol and 20% ethyl acetate.

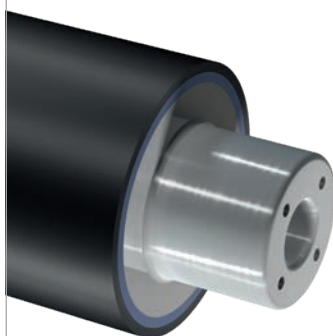

Microlast

Elastomero a bassa densità con alte proprietà elastiche anche noto come "gomma spugna"; viene utilizzato in genere per il rivestimento di rulli stenditori del materiale da stampare nelle stazioni di svolgimento e avvolgimento. Pulizia con miscela di 75% alcool etilico e 25% acetato d'etile.

Low density elastomer with high elastic properties also known as "foam rubber"; it is generally used for coating of spreader roller of the material to print in unwinding and winding stations. Cleaning with a blend of 75% ethyl alcohol and 25% ethyl acetate.



Tutte le speciali mescole Rossini sono disponibili sia nella configurazione Speedwell Sleeve che rullo gommato.
All the special Rossini compounds are available both in Speedwell Sleeve configuration and rubber roller.



**laminazione
e spalmatura**
*lamination
and spreading*



LAMINATION AND SPREADING

**Silicone**

Elastomero siliconico indicato ove si richieda antiadesività. Adatto per applicazioni extrusion coating, hot melt, cold seal e spalmatura cere. Può lavorare fino a temperature di 200 °C. Pulizia con 100% alcool etilico.

Silicone elastomer particularly indicated where non-stick properties are required. Suitable for extrusion coating, hot melt, cold seal and wax coating. It can work up to 200 °C temperature. Cleaning with 100% ethyl alcohol.

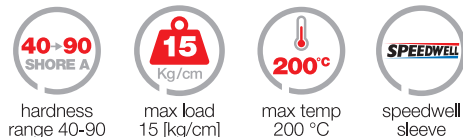

hardness range 40-90



max load 15 [kg/cm]



max temp 200 °C

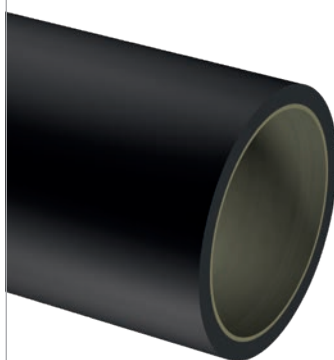

speedwell sleeve

**PU**

Tecnopolimero formulato per spalmatura colle senza solvente e silicone (durezza 65 Shore A) **disponibile anche nella versione antistatica.** Pulizia con benzine oppure con miscela di 80% alcool etilico e 20% acetato d'etile.

Technopolymer designed to spread solventless glue and silicon (hardness 65 Shore A) and available also in antistatic construction. Cleaning with gasoline or with a blend of 80% ethyl alcohol and 20% ethyl acetate.

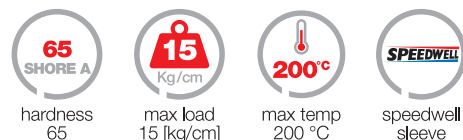

hardness 65



max load 15 [kg/cm]



max temp 200 °C

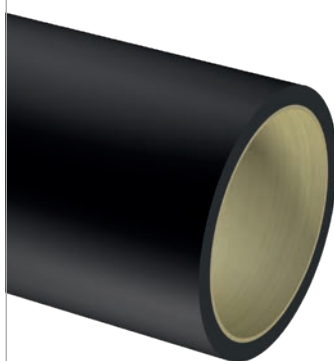

speedwell sleeve

**Neoflex C Stat**

Elastomero specifico per spalmatura e/o pressore di spalmatura con colle e/o caseine senza solventi. Pulizia con miscela di 80% alcool etilico e 20% acetato d'etile.

Special elastomer for spreading or spreading rubber impression rollers in presence of water or alcohol based glues and/or casein. Cleaning with a blend of 80% ethyl alcohol and 20% ethyl acetate.

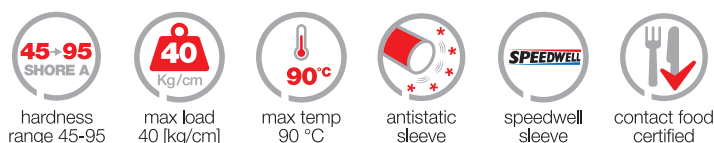

hardness range 45-95



max load 40 [kg/cm]



max temp 90 °C



antistatic sleeve



speedwell sleeve

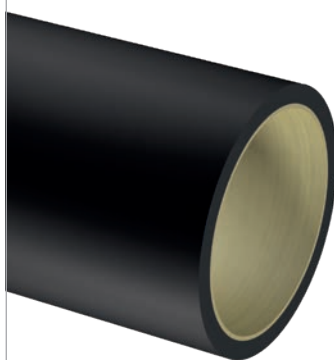

contact food certified

**Neoflex G Stat**

Elastomero specifico per spalmatura e/o pressore di spalmatura in presenza di inchiostri a base solventi acetati, alcoli, MEK e max 20% toluene. Pulizia con 100% acetato d'etile.

Special elastomer for spreading or spreading rubber impression rollers in presence acetate, alcohol, MEK and max 20% toluene. Cleaning with 100% ethyl acetate.

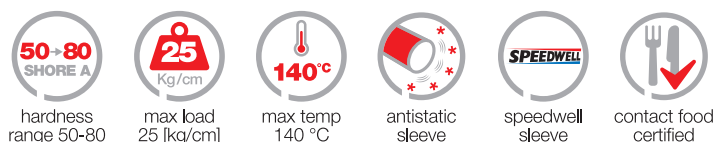

hardness range 50-80



max load 25 [kg/cm]



max temp 140 °C



antistatic sleeve



speedwell sleeve



contact food certified

Tutte le speciali mescole Rossini sono disponibili sia nella configurazione Speedwell Sleeve che rullo gommatto.
All the special Rossini compounds are available both in Speedwell Sleeve configuration and rubber roller.

LAMINATION AND SPREADING

Polycoat Green

Elastomero ideato per il rivestimento di rulli e Speedwell sleeves specifico per spalmatura colle bicomponenti senza solvente.

Il polimero di base addizionato con componenti antiadesivi evita la chiusura delle celle sulla superficie esterna durante il lavoro e mantiene il valore ideale di tensione superficiale per la spalmatura del materiale riducendo il consumo di colla se paragonato a rivestimenti tradizionali.

La tensione superficiale e quindi la bagnabilità della gomma è inoltre legata a vari parametri di produzione come la rugosità superficiale, l'uniformità e la purezza della struttura molecolare utilizzata nella corretta formulazione.

Per mantenere queste importanti caratteristiche tecniche Rossini consiglia una rettifica della tavola su base annuale e una corretta pulizia ordinaria che preveda l'uso di adeguati prodotti softener oltre al solvente - 100% acetato d'etile.

Elastomer to coat rollers and Speedwell sleeves specifically for spreading solvent-less, two-component glues.

The base polymer is blended with non-stick additives that avoid the closure of the cells on the outer surface during work and maintain the ideal surface tension value for guaranteeing a uniform distribution and thickness of the adhesive layer with a considerable saving on the total amount of used glue when compared to traditional rubbers.

Moreover the surface tension and the wettability of the rubber is also connected to different other production parameters like external roughness, uniformity, purity and correct formulation of the compound.

In order to maintain the technical characteristics of Polycoat, Rossini suggests a yearly grinding of the external surface and a proper cleaning procedure with the use of specific softener in addition to the solvent – 100% ethyl acetate.



max load
25 [kg/cm]



max temp
140 °C



speedwell
sleeve



contact food
certified

Hypalon F - Hypalon F Stat

Elastomero per rivestimento rulli accoppiatori, ideale per spalmatura di adesivi monocomponenti senza solvente e hot melt; è utilizzato anche per spalmatura di silicone, cere e paraffine grazie alla sua stabilità a alta temperatura. Disponibile nella configurazione antistatica. Procedura di pulizia con utilizzo di miscela di 50% alcool etilico e 50% acetato d'etile.

Elastomer designed to coat lamination rollers and specifically to spread mono-component, solvent-free adhesives and for hot melt coating; it is also used for silicone, wax and paraffins spreading. Available in the antistatic configuration. The cleaning procedure is with a blend of 50% ethyl alcohol and 50% ethyl acetate.



hardness
range 60-95



max load
25 [kg/cm]



max temp
160 °C



antistatic
sleeve



speedwell
sleeve

Dual Black Sleeve - Dual Nickel Sleeve

Speciale applicazione del progetto Speedwell Sleeve per costruire pressori di spalmatura in alluminio per adesivi a base solvente con i vantaggi tipici del sistema a maniche (cambio rapido e maneggevolezza).

Special application of the Speedwell Sleeve project to build coating press in aluminum for solvent-based adhesives with the typical advantages of the sleeve system (quick change and easy handling).

- **Dual Black** Sleeve in alluminio anodizzato
- **Dual Nickel** Sleeve in alluminio rivestita in nickel

- **Dual Black** Sleeve in anodized aluminium
- **Dual Nickel** Sleeve in nickel-coated aluminium



antistatic
sleeve



high
longevity



humidity
resistant



manual
handling



more
productivity



quality
certified

Tutte le speciali mescole Rossini sono disponibili sia nella configurazione Speedwell Sleeve che rullo gommato.
All the special Rossini compounds are available both in Speedwell Sleeve configuration and rubber roller.



offset
offset



ROTO OFFSET GAPLESS PRINTING SLEEVES

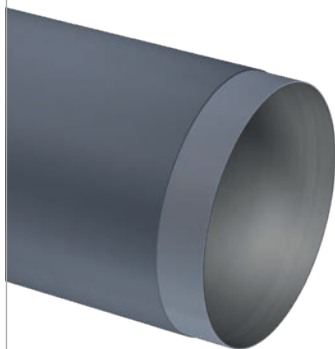

Leonardo

La prima e unica sleeve senza gap in poliuretano per uso su macchine da stampa roto-offset per pubblicazioni con configurazione sleeve. Materiali innovativi sono stati selezionati per competere ai più alti livelli di qualità con immagini stampate in alta definizione grazie a un perfetto punto stampa e per raggiungere la miglior efficienza produttiva. La tecnologia Rossini nella produzione è garanzia di una stabile e corretta interferenza tra la sleeve e il mandrino della macchina per una produzione di alti volumi mantenendo inalterate caratteristiche meccaniche nel tempo per un facile montaggio della sleeve in macchina. Meccanicamente molto resistente a possibili rotture lastra/carta e al taglio generato dai bordi della carta durante il processo di stampa.

- Punto stampa in accordo alle specifiche OEM (non necessaria nuova e specifica calibrazione della macchina)
- Risposta elastica (rebound), interferenza geometrica, pressione di stampa e proprietà meccanica in accordo con le specifiche OEM
- Avanzamento carta uniforme che garantisce un corretto set-up macchina e start di produzione; un solo modello di sleeve per le varie unità stampa
- Le proprietà meccaniche del poliuretano garantiscono una durata superiore, tempi ridotti per la pulizia in stampa e più produttività non essendo necessario cambiare la sleeve al cambio larghezza materiale in stampa
- Prodotto disponibile per tutte le macchine da stampa presenti sul mercato roto-offset.

The first and unique polyurethane gapless sleeve designed for roto-offset printing presses with sleeves configuration with superior print quality, longevity and product's reliability. New materials have been selected to compete to the highest levels of quality with final printed images in high definition thanks to a perfect dot gain and to achieve the best production efficiency. Rossini's production technology guarantees a stable and correct interference between the sleeve and the press mandrel for high volumes quality production and easy-handling during the mounting operation in the press over time. Unique smash recovery and mechanical resistance during the printing process with virtually no memory effects when changing web size.

- Dot gain according OEM's specs (no need of new and specific calibration of the machine)
- Rebound, interference gauge, printing pressure and mechanical properties fully matching OEM's technical specs
- Uniform web feed behavior (slightly positive) for excellent and fast press set-up with no need of specific selection of the sleeve for the different printing unit (only one sleeve type available)
- The PU mechanical smash recovery guarantees longer life, less downtime, easier cleaning of the surface and more productivity
- Proven product on several machines
- Product available for all the printing presses of the roto-offset market.



HD print level



mechanical resistance



solvent resistant



high longevity



more productivity

OFFSET PRINTING SLEEVES VARIABLE FORMAT

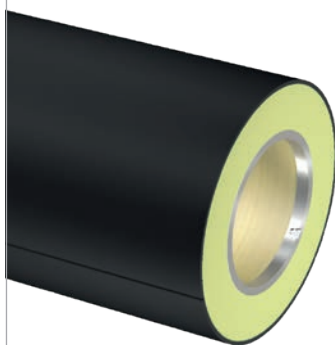

Lito Black Plate

Sleeves porta-lastra progettate per uso su macchine roto-offset a sviluppo variabile nei range 14"-32" specialmente indicate per la stampa etichette e banda stretta (narrow web).

La tipologia di prodotto è totalmente incapsulata in fibra di vetro e sulla superficie esterna presenta uno strato di speciale poliuretano PU. Il layer di poliuretano ad alto spessore viene poi lavorato nella Lito Plate per ricavare la fresatura di aggancio della lastra in alluminio per stampa offset. L'anello di protezione in acciaio integra la cava di registro.

Plate mounting sleeve for use on roto-offset presses with variable format in the printing range 14" – 32" especially designed for label and narrow web printing.

The sleeves are totally encapsulated in fiberglass with an external layer of special polyurethane PU Everstat.

The high thickness PU layer of the Lito Black Plate Sleeve has the special offset plate holding configuration to allow the installation of the aluminum offset plate. The protection steel ring integrates the register notch.



humidity resistant



mechanical resistance



protection ring



solvent resistant

OFFSET PRINTING SLEEVES VARIABLE FORMAT



Lito Glass Blanket

Sleeve porta caucciù utilizzabile su macchine roto-offset a sviluppo variabile (range 14" - 32"). La sleeve è totalmente incapsulata in fibra di vetro con uno strato esterno in resina epossidica garantendo una perfetta stabilità dimensionale nel tempo e una eccellente resistenza chimica ai solventi e all'umidità. Sulla superficie esterna viene realizzata 1 riga orizzontale di riferimento per il montaggio del caucciù. L'anello di protezione in acciaio integra la cava di registro.

Blanket mounting sleeve for use on roto-offset presses with variable printing (range 14" - 32"). The sleeve is totally encapsulated in fibreglass with an external layer of epoxy resin guaranteeing a perfect dimensional stability over time and excellent chemical resistance against solvents and humidity. Over the external surface is made an horizontal line as a reference for blanket mounting. The protection steel ring integrates the register notch.



HD print level



humidity resistant



mechanical resistance



protection ring



solvent resistant

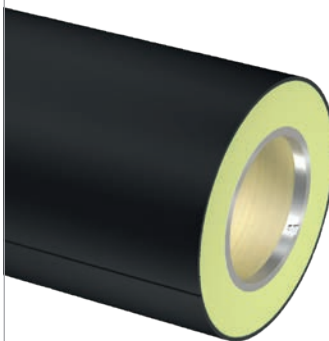

Lito Black Blanket

Sleeve porta caucciù utilizzabile su macchine roto-offset a sviluppo variabile (range 14" - 32"). La sleeve è totalmente incapsulata in fibra di vetro con uno strato esterno in poliuretano PU Everstat, sulla superficie esterna viene realizzata una riga orizzontale di riferimento per il montaggio del caucciù; l'anello di protezione in acciaio integra la cava di registro.

Blanket mounting sleeve for use on roto-offset presses with variable printing (range 14" - 32"). The sleeve is totally encapsulated in fibreglass with an external layer of special polyuretane PU Everstat over the external surface in made and horizontal line as a reference for the blanket mounting. The protection steel ring integrates the register notch.



HD print level



humidity resistant



mechanical resistance



protection ring



solvent resistant

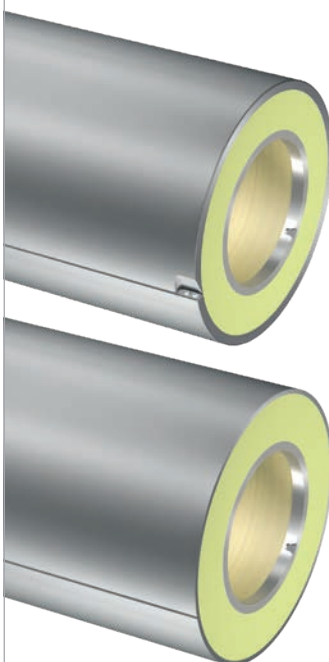

Alu Plate - Alu Blanket

Sleeves porta-caucciù e porta-lastra progettate per uso su macchine roto-offset a sviluppo variabile nei range 14" - 32" specialmente indicate per la stampa etichette e banda stretta (Narrow Web).

Blanket and plate mounting sleeve for use on roto-offset presses with variable format in the printing range 14" - 32" especially designed for label and Narrow Web printing.

La tipologia di prodotto Alu Sleeve è totalmente incapsulata in fibra di vetro e monta un tubo in speciale alluminio sulla superficie esterna per una totale garanzia di mantenimento del repeat di stampa e resistenza ai solventi usati in ambito stampa offset.

The products Alu Sleeve are totally encapsulated in fibreglass and mount a special aluminum tube as external surface for a unique guarantee of repeat conservation and resistance to the chemicals used in offset printing.

Il peso dell'alluminio è inoltre compensato dalla struttura interna in materiale ultra-leggero che garantisce inoltre una eccezionale rigidità meccanica alla sleeve.

Moreover the aluminum weight is compensated by the internal structure in material that guarantees an exceptional mechanical strength to the sleeve.

La **Alu Plate** presenta un tubo di alto spessore con la necessaria lavorazione di fresatura per l'aggancio della lastra per stampa offset, mentre la **Alu Blanket** ha uno spessore ridotto di alluminio con una riga orizzontale di riferimento per il montaggio del caucciù.

*The **Alu Plate** sleeve has a high thickness aluminum tube with the special offset plate holding configuration to allow the installation of the offset plate while the **Alu Blanket** has a lower thickness tube with an horizontal line as a reference for blanket mounting.*

L'anello di protezione in acciaio integra la cava di registro.

The protection steel ring integrates the register notch.



HD print level



humidity resistant



mechanical resistance



protection ring



solvent resistant



**rulli e mandrini
pneumatici per sleeves**
*roller and pneumatic
sleeve mandrels*



CARBON FIBRE MANDRELS AND IDLE ROLLERS

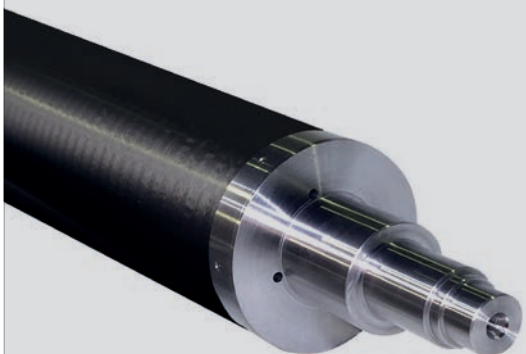
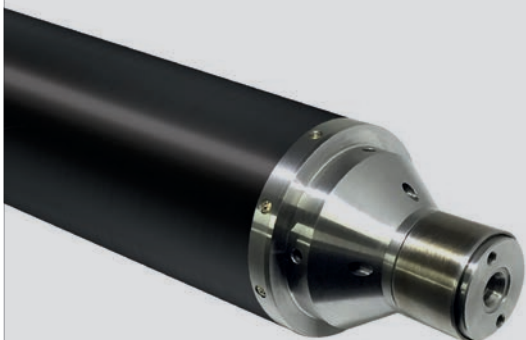

Mandri e rulli folli in fibra di carbonio

Carbon fibre mandrels and idle rollers

Mandri pneumatici e rulli in fibra di carbonio sono progettati per avere un peso ridotto, un'alta frequenza critica/naturale di rotazione così come una flessione minimizzata in base al carico applicato; sono disponibili con perni in alluminio e/o acciaio in base alle specifiche OEM. Peso ridotto, bassa inerzia in rotazione e longitudinale permettono velocità di rotazione più elevate, riduzione delle vibrazioni, incremento della vita dei cuscinetti, riduzione degli scarti e miglioramento della qualità del prodotto finito. Prestazioni decisamente migliori se confrontati a mandri in acciaio specialmente quando sono richiesti grandi larghezze di carta, alti carichi e alte velocità di produzione.

I Tubi in CFKP offrono numerosi vantaggi se paragonati all'acciaio:

- Grande riduzione di peso fino al 70% più leggero dell'acciaio
- Capacità di assorbimento delle vibrazioni progettabile in base alle condizioni di processo
- Alta oppure bassa rigidità calcolabile in base alle esigenze
- Alta stabilità termica e quindi non presenta deformazioni anche in prossimità di sorgenti di calore
- Frequenza di risonanza (natural) in base alla necessità
- Alta resistenza alla corrosione e all'attacco chimico in genere
- Alta resistenza alla fatica

I tubi in fibra di carbonio possono essere rivestiti con la maggior parte dei materiali utilizzati per rivestire i tubi in acciaio. Sono disponibili come standard molti rivestimenti quali carburo di tungsten, cromo, elastomeri vari in base all'applicazione, poliuretano, etc. Contattate il nostro ufficio tecnico per eventuali richieste particolari.

Carbon fibre mandrels and idle rollers are designed for reduced weight and high critical/natural speed as well for a minimized deflection to the applied load; they are available with aluminum or steel inserts according OEM's specs. Lightweight, low-rotational or translational inertia allow faster speeds, reduced vibration, increased bearing lifetime, decreased waste and improved quality of the final products. Better performance than traditional steel mandrel particularly when wide web widths, heavy loads, and faster speeds are needed.

CFKP tube offers numerous advantages compared to steel:

- Massive weight reduction up to 70% lighter than steel
- Adjustable damping
- Very high rigidity or soft if you like
- High thermal stability and thus no deformations in the vicinity of heat sources
- Resonance frequency following your requirements
- Corrosion and chemical resistant roller body
- Very high fatigue strength

Carbon fiber tubes can be coated with most of the same materials that metal rollers can be coated with. Many standard coatings are available like tungsten carbide, chromium, elastomer, polyurethane, but please ask if you need a specific type of coating.

Contact our technical office for any special requests.



high longevity



humidity resistant



manual handling



mechanical resistance



quality certified

Macchina avvolgimento filamenti.

Filament winding machine.

SLEEVE MOUNTING MANDRELS



mechanical resistance



patented product



quality certified



Speedwell System

Mandrini Speedwell System

Speedwell System mandrels

Rossini fornisce mandrini conici per le Speedwell Sleeves gommate di sua produzione. Costruito con le migliori tecnologie disponibili per l'esecuzione delle lavorazioni meccaniche, del processo di saldatura e assemblaggio, il mandrino Rossini Speedwell conta su un corretto dimensionamento in funzione dei carichi richiesti dal produttore della macchina, la brevettata conicità e un sistema a camera chiusa per la distribuzione dell'aria compressa oltre a una perfetta rettifica della tavola fornibile con rivestimento di cromatura, nichelatura in base al disegno costruttivo.

Rossini supply tapered mandrels for the rubber Speedwell Sleeves of its production. Manufactured with the latest available technologies for the mechanical works, welding process and assembly, the Rossini Speedwell mandrel has several advantages like the design related to the applied loads, the patented tapered value and a close chamber distribution system for the compressed air distribution; moreover the perfect grinding of the surface supplied with chrome, nickel coating according to the manufacturing drawing.



mechanical resistance



patented product



quality certified



Speedwell System

Mandrini Speedwell System anti-arco

Speedwell System anti-deflection mandrels

Speciale costruzione anti-arco del mandrino in grado di supportare le Speedwell Sleeves gommate in impieghi gravosi. Il mandrino ha la brevettata conicità, il sistema a camera chiusa per la distribuzione dell'aria compressa oltre a una perfetta rettifica della tavola con eventuale rivestimento di cromatura, nichelatura in base al disegno costruttivo che consente un agevole e corretto montaggio della manica gommata Speedwell.

Special anti-deflection design of the mandrel for using the rubber Speedwell sleeves in heavy-duty applications. The mandrel has the patented tapered value, a close chamber distribution system for the compressed air and moreover the perfect grinding of the surface that can be supplied with chrome, nickel coating according to the manufacturing drawing for the easy and proper mounting of the rubber Speedwell Sleeves.



Nuova Officina Meccanica con macchine CNC.
New mechanical workshop equipped with CNC machines.

SLEEVE MOUNTING MANDRELS

Mandri in acciaio paralleli per stampa flexo*Parallel steel mandrels*

Mandri pneumatici in acciaio paralleli per il montaggio delle sleeve porta lastra, carrier e anilox per macchine da stampa flessografiche e mandri speciali per macchine monta-cliché.

Costruito con le migliori tecnologie disponibili per l'esecuzione delle lavorazioni meccaniche, del processo di saldatura e assemblaggio, il mandrino Rossini conta su un corretto dimensionamento in funzione dei carichi richiesti dal produttore della macchina OEM e un sistema a camera chiusa per la distribuzione dell'aria compressa oltre a una perfetta rettifica della tavola fornibile con rivestimento di cromatura, nichelatura in base al disegno costruttivo.

Parallel pneumatic steel mandrels for mounting plate sleeves, carriers and anilox for flexographic printing machines and special mandrels for plate mounting stations.

Manufactured with the latest available technologies for the mechanical works, welding process and assembly, the Rossini mandrel has several advantages like the correct design related to the applied loads defined by OEM machine manufacturer and a close chamber distribution system for the compressed air distribution; moreover the perfect grinding of the surface that can be supplied with chrome, nickel coating according to the manufacturing drawing.



mechanical
resistance



quality
certified

Mandri in acciaio raffreddati/riscaldati*Cooled/heated steel mandrels*

Rossini progetta e produce mandri speciali in acciaio termostatabili (in raffreddamento o riscaldamento) in configurazione Speedwell per macchine da stampa e accoppiatrici; rulli calandra per il raffreddamento o il riscaldamento di film plastici.

L'ufficio tecnico Rossini garantisce una corretta progettazione del pezzo una volta stabilite le condizioni d'impiego secondo le specifiche/disegni OEM con o senza spirale per circolazione fluidi, a flusso semplice o a doppio flusso incrociato, con ingresso e uscita fluido dallo stesso lato oppure da lati opposti.

Il mandrino viene fornito completo di bussole per cuscinetti, tempra induzione o altro trattamento sui perni inclusa la bilanciatura in base al disegno costruttivo OEM.

Rossini designs and manufactures special steel mandrels with temperature control (in cooling or heating version) in Speedwell configuration for flexographic printing and lamination machines; calender rollers for cooling or heating plastic films.

Rossini's technical office grants a proper design of the component upon OEM's specifications/drawings with or without spiral for fluid circulation, with simple or double crossed flow, with fluid in and out from the same side or from opposite sides.

The mandrel is supplied with tempered bushes, induction tempering or any other thermal treatments on the shafts, dynamic balanced according to the OEM's drawing.



mechanical
resistance



quality
certified



equipment
equipment



Evolution System

Impianto automatico per pulizia tamburi stampa flessografica
Automatic system for flexo central impression drum cleaning

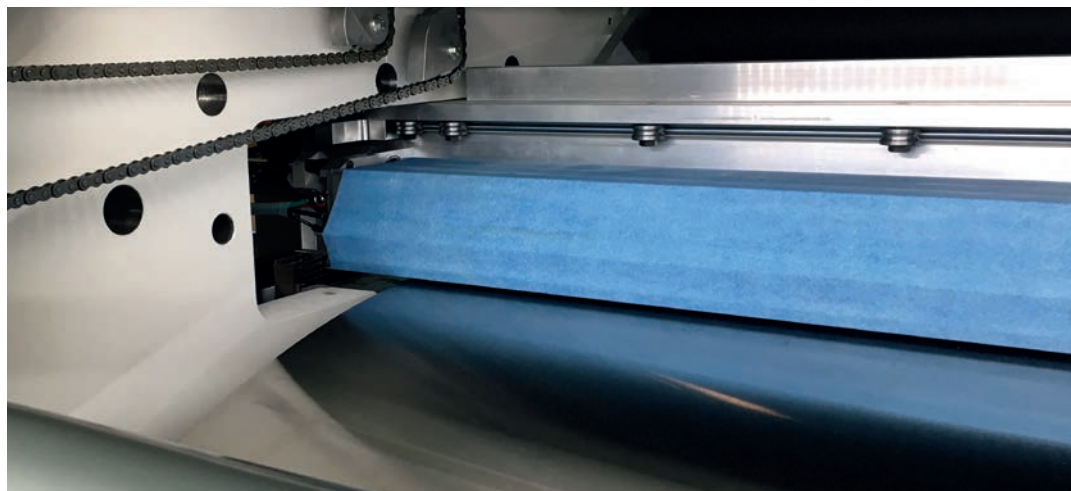

Evolution System è l'innovativo sistema oscillante brevettato con tecnologia a panno inumidito con detergente per la pulizia del cilindro stampa flexo dai residui d'inchiostro.

Rapidi e giornalieri cicli di pulizia automatici garantiscono sicurezza, flessibilità e costante qualità di stampa.

L'intuitiva interfaccia operatore del pannello di controllo permette di selezionare il corretto programma di lavaggio (corto – medio – lungo) in base al deposito d'inchiostro da rimuovere.

Evolution System incrementa l'efficienza eliminando i tempi di fermo macchina per la pulizia manuale del tamburo e garantisce maggiore flessibilità nella pianificazione della produzione virtualmente eliminando i vincoli di larghezza lavoro.

Idoneo sia per pulizia di residui di inchiostri a base acqua che a base solvente; è ora disponibile la configurazione a doppia tanica per un rapido e pulito cambio del detergente necessario (opzionale).

Il sistema è certificato:
 ATEX - CE - UL/CSA (su richiesta).

Componenti del sistema

- Testa di lavaggio completa di piastre laterali per montaggio in macchina
- Touch-Panel/PLC per interfaccia operatore con swich per connessione remota tramite internet
- Unità di contenimento e pompaggio detergente
- Unità di controllo elettro-pneumatico
- Set di cavi e tubi per interconnessione componenti

Consumabili

- Rotoli di panno pre-avvolti: fornitore - Rossini
- Detergente: il cliente acquista dal mercato in base a una lista di agenti pulenti selezionati da Rossini

Evolution System is the innovative, patented, oscillating system using controlled-soaked cloth technology to remove the ink residues from the flexo central impression drum.

Fast automatic washing cycles for daily use guarantee safety, flexibility and constant printing quality.

The intuitive operator interface of the control panel enables the proper selection of the cleaning programs (short – medium – long) depending on the ink residue to be removed.

Evolution System increases the productivity of the machine by eliminating press downtime for manual cleaning and guarantees greater flexibility in the production planning virtually reducing working width range constraints.

Suitable for cleaning both water and solvent based inks residuals, it is now available the double tank configuration for clean and quick detergent switch (optional).

*System's certifications:
 ATEX - EC - UL/CSA (upon request).*

System components

- Washing head complete with side plates for installation
- Touch Panel PLC for operator interface with switch for internet remote connection
- Electro-Pneumatic control box
- Detergent tank
- Set of cables and tubes for the connection between the different components

Consumables

- Pre-winded cloth roller: supplier - Rossini
- Detergent: the customer purchases from the market according Rossini approved solvent list



Storage System

Sistema modulare per stoccaggio sleeves, anilox e carrier
Modular system to store sleeves, anilox and carriers

Sistema manuale per immagazzinamento flexo sleeves portalastra, carriers e anilox in posizione verticale; semplice, agevole e sicuro è costituito da moduli (Rack) fissi posizionati alle estremità e mobili. Modulare, espandibile nel tempo e altamente personalizzabile nelle dimensioni permette di gestire in modo rapido e sicuro l'intero parco prodotti grazie a una agevole manipolazione, lo stoccaggio su più livelli (due oppure tre in base alla dimensioni dei prodotti) e la possibilità di tenere un registro dei prodotti posizionati in ogni rack. Di facile e rapida installazione, Storage System garantisce il recupero degli spazi oggi sotto-utilizzati evitando possibili deformazioni ai prodotti (come ovalizzazione e quindi impossibilità di utilizzo) dovute all'eventuale stoccaggio per lungo periodo in posizione orizzontale e/o danni dovuti a cadute e contatti accidentali.

Struttura

- Struttura durevole in acciaio anti-torsione verniciato
- Altezza ripiani regolabile per varie lunghezze di sleeves/anilox
- Elementi scorrevoli su entrambi i lati
- Disposizione sleeves su più file in base al diametro esterno
- Sistema modulare ed espandibile nel tempo
- Elevata capienza e stabilità

Manual system for simple, easy and safe vertical storage of flexo plate sleeves, carriers, anilox composed of fixed racks on the lateral sides and internal mobile modules (racks). Modular, expandable over time and with highly customisable, it enables fast and safe management of the entire products' park. Easy and quick to install, Storage System guarantees the reduction of the usage of the space thanks to the storage on two (or three) levels of the products in each rack and the correct vertical storage of sleeves avoiding possible deformations (ovalisation) due to eventual storage for long periods in a horizontal position or damages due to accidental contacts or falls.

Structure

- Long-lasting structure in painted, torsion-resistant steel
- Adjustable shelving height for sleeves/anilox in various lengths
- Sliding elements on both sides
- Sleeves arranged over multiple rows based on the external diameter
- Modular and expandable system over time
- High capacity and stability



EC Norm
compliant



manual
handling



compact
design



patented
product

Robotic Sleeve Storage

Impianto per stoccaggio automatizzato sleeves, anilox e carrier
Automated storage system for sleeves, anilox and carriers



Innovativo sistema automatizzato di immagazzinamento verticale per sleeves porta-lastra, carrier e anilox rollers.

Altamente personalizzabile permette di gestire in modo rapido e sicuro l'intero parco sleeves; i prodotti sono posizionati verticalmente su ripiani di appoggio inseriti su sistemi di centraggio opportunamente dimensionati in funzione del diametro e della lunghezza della manica; il numero di sleeves stoccabili per ripiano varia in funzione del diametro esterno della sleeve stessa.

Il sistema di prelievo roto-traslo del ripiano garantisce la possibilità di trasporto alle postazioni di scarico e carico dei prodotti in pochi minuti rendendo agevole e immediata l'individuazione delle maniche per la preparazione dei lavori grazie a un semplice ma dettagliato software proprietario di gestione; il numero e dimensionamento dei sistemi roto-traslo di "pick-up and place" è funzione del numero di pezzi immagazzinati e richiesti al minuto nel punto di scarico che sono definiti in sede di ordine.

Il Robotic Sleeve Storage garantisce il recupero degli spazi oggi utilizzati e una corretta manipolazione delle sleeves evitando possibili deformazioni (ovalizzazione) dovute all'eventuale stoccaggio per lungo periodo in posizione orizzontale e/o danneggiamenti per cadute o urti accidentali. L'impianto è certificato CE e la rete vendita e i tecnici Rossini sono a disposizione per proporvi la vostra soluzione personalizzata.

Innovative automated vertical storage system for flexo plate sleeves, carriers and anilox.

Highly customizable it allows the quick, easy and safe handling of the complete park of products; the different products are stored in vertical position on shelves and inserted in centering devices designed depending on sleeves dimensions (lengths, inner and outer diameter); the number of sleeves per shelf is related to the outer diameter.

The pick and place system grants the delivery of the products in few minutes to the operator's place with an easy and fast identification of the sleeves thanks to an operator friendly software interface; the number and design of the pick-and place systems is related to the number of stored products and the number of pieces requested to the operator's place per minute that are defined with the purchase order.

The Robotic Sleeve Storage guarantees recovery of space used today and correct storage of sleeves, avoiding possible deformations (ovalisation) due to eventual storage for long periods in a horizontal position or damages due to accidental contacts or falls.

The system is EC certified.

The sales and technical network of Rossini are available to work with you for your tailor-made solution.



EC Norm compliant



mechanical resistance



compact design



customizable control

Rettifiche Prima *Prima Grinders*

Rettifiche per maniche e rulli rivestiti in gomma e/o tecnopolimeri
Grinders for sleeves and rollers coated in rubber and/or technopolymers

Precisione, ripetibilità e affidabilità sono le principali caratteristiche della rettificatrice cilindrica per esterni PRIMA progettata con pezzo fisso e tavola porta-mola mobile per lavorazione di maniche e rulli rivestiti in gomma e/o tecnopolimeri.

La doppia funzione di sbazzatura iniziale (tornitura) e rettifica di precisione finale incorporate nel design della tavola mobile rendono PRIMA il prodotto ottimale per ogni vostro intervento permettendo tutte le fasi di lavorazione con un unico posizionamento del pezzo garantendo massima precisione e prestazioni superiori grazie ai due assi indipendenti della mola e utensile.

L'ingombro ridotto della macchina, l'eliminazione dei magazzini intermedi non più necessari perché il pezzo viene finito direttamente in macchina, la ridotta manutenzione e un rapido ROI sono solo alcuni dei vantaggi di questa innovativa macchina; il montaggio del quadro elettrico solidale col telaio macchina rende PRIMA un sistema plug and play pronto all'uso dopo le necessarie operazioni di installazione (fissaggio e messa in bolla, connessione alle utenze).

Opzionale configurazione macchina per rettifica con lubrorefrigerante.

Precision, repeatability and reliability are the relevant features of the PRIMA GRINDER designed with fixed roller and movable grinding wheel to work on rubber or polymer coated sleeves (on mandrels) or solid rollers.

The double function of preliminary lathing and final high precision grinding installed on the movable table makes the PRIMA GRINDER the top product for your job thanks to a single positioning of the roller for all the different working phases, guaranteeing maximum precision levels and superior performance.

The optimized footprint, the minimized maintenance and a fast ROI are some of the advantages of this innovative machine; the assembly of the electrical board on the machine's frame makes the PRIMA GRINDER a plug&play system ready for use after the installation procedure (fixing and leveling).

Optional machine configuration for grinding with coolant lubricant.

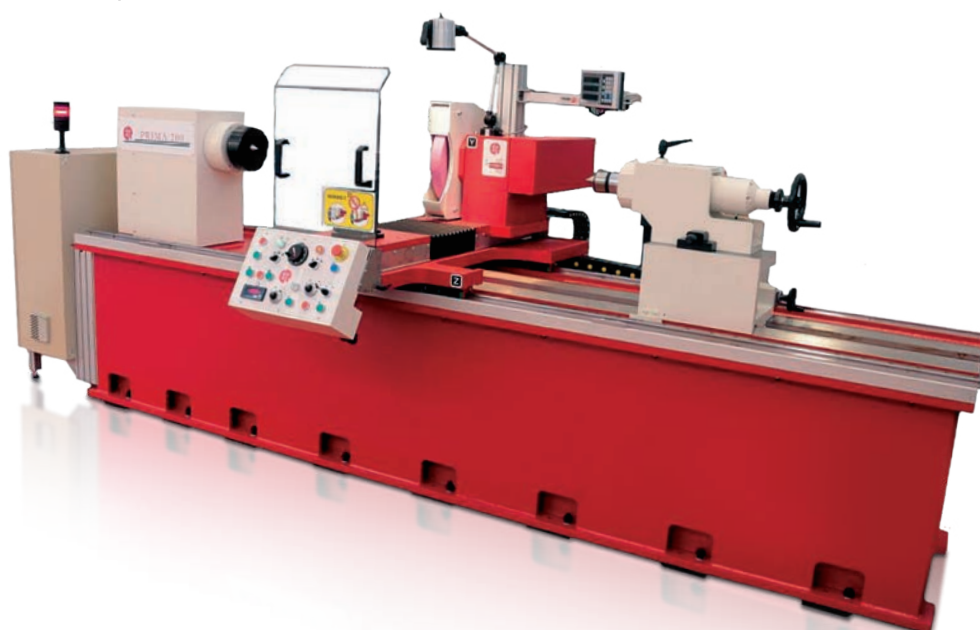

EC Norm compliant



mechanical resistance



compact design



rubber and polymer

PRIMA STANDARD

Idonea alle lavorazioni di sbazzatura e rettifica cilindrica. Gradinatura esterna e intestatura pezzo. Funzione di pendolamento della mola su camma regolabile manualmente con incrementi asse orizzontale manuali. Ciclo di diamantatura con incrementi e spostamenti manuali. Equipaggiamento standard: torretta porta-utensile a una posizione. Quote sui tre assi visualizzate.

This model is designed for the following operations: external steps and roller facing; grinding wheel and lathing tool swing function on manually adjusted cam with manual horizontal axis increments; manual grinding wheel adjustment cycle. Standard equipment: one position tool holder, digital display for the three axis positioning.

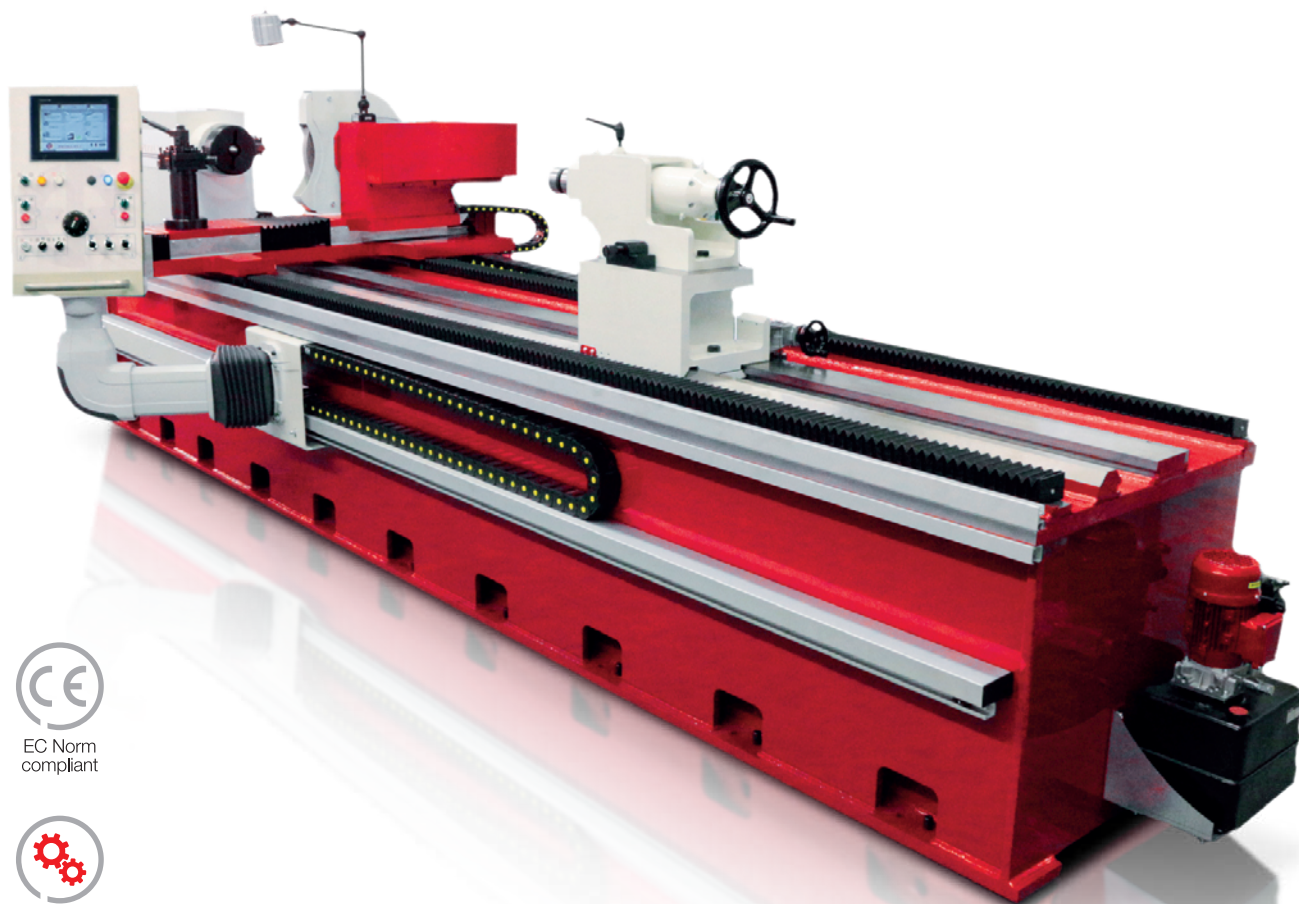

EC Norm
compliant



mechanical
resistance



more
productivity



customizable
control



compact
design



rubber and
polymer



management
operations

PRIMA PLC

Il software Rossini permette una comunicazione e gestione scambio dati con sistema gestionale aziendale in conformità a INDUSTRY 4.0.

Idonea alle lavorazioni di sbazzatura e rettifica cilindrica. Gradinatura esterna e intestatura pezzo con ciclo automatico di diamantatura.

La gestione dell'avanzamento mola/utensile e del pendolamento del pezzo è totalmente controllata tramite motori con encoder.

La presenza del controllo tramite PLC garantisce la gestione del ciclo di lavoro a cascata nelle varie fasi previste e la ripetizione su più pezzi (serie).

Ulteriori lavorazioni possibili di finitura esterna: profilo cilindrico, conico, trapezoidale e bombatura concava e convessa (con opportune geometrie della mola); sagomatura a gradini, smussi sagomati.

Rossini Software allows a communication and data management with the customer's management data system according to the specs of INDUSTRY 4.0 (Italy). PRIMA PLC makes lathing and precision grinding of the external surface, steps, roller/sleeve facing and the automatic wheel adjustment cycle an easy task. The grinding wheels and lathing tool movement on two independent axis and the horizontal moving function is controlled through encoders applied on motors with specific automatic handling software. The PLC allows a seamless work flow operation on the roller/sleeve and has a memory function to recall set parameters for repeat jobs (series production). Standard grinding profiles: Parallel profile (standard), tapered profile, trapezoidal profile, crowned (cambered) surface convex or concave (with specific grinding wheels shapes), stepped shaping, edge trimming.



EC Norm
compliant



mechanical
resistance



more
productivity



customizable
control



compact
design



rubber and
polymer



management
operations

PRIMA XL PLC

Come la PRIMA PLC consente tutte le operazioni su rivestimenti gommati e/o tecno-polimeri sopra riportate su pezzi di dimensioni rilevanti fino a:

- Lunghezza fino a 8 m tra le punte (corredata di lunette dimensionate allo scopo di fornitura)
- Diam. max 600 [mm]

Una struttura in carpenteria elettro-saldata fortemente irrigidita e l'utilizzo di guide a giochi ridotti permette il mantenimento di tolleranze ristrette della lavorazione tavola esterna entro i 0,02 [mm] sul diametro anche per lunghezze di rettifica decisamente importanti.

Like the PRIMA PLC, it allows all the above described operations on sleeves and rollers with rubber or techno-polymer coating on bigger dimensions up to:

- 8 [m] width between the centers (equipped with handling tools sized for the purpose of supply)
- Max dia. 600 [mm]

Solid stiffened electro-welded steel structure, more powerful motors, newly re-sized components and the assembly with new high precision guides keep the tolerance of the rubber surface within 0,02 [mm] even for such big rollers.

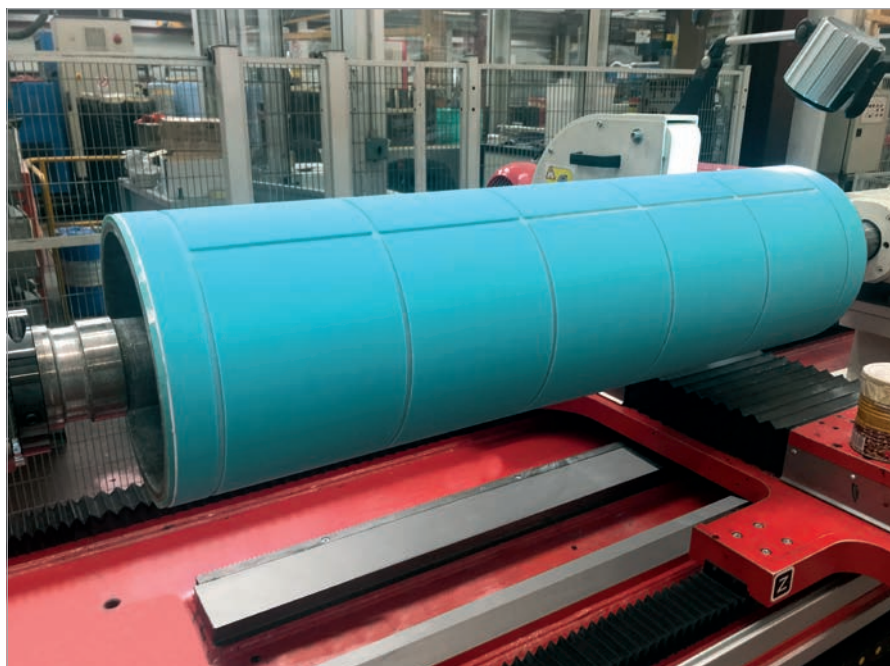

PRIMA PLC
GROOVES
mod. 200



PRIMA PLC GROOVES

L'ultimo prodotto nato dalla famiglia Prima è costruito sulla base della Prima PLC.

È stato progettato con un'asse rotazionale dotata di un encoder per permettere il posizionamento angolare del rullo e l'uso di accessori speciali elettromotorizzati ad alta velocità integrati nella stazione porta-utensili per eseguire fresature orizzontali o circolari sulla superficie in gomma o tecno-polimero.

Un nuovo software dedicato consente di fresare linee orizzontali e circolari sulla copertura in gomma o tecno-polimero a diverse profondità e dimensioni, e offre una funzione di ripetibilità per la produzione in serie; ideale per il settore della stampa su materiali metallici.

The last product born out of the Prima family is built on the basis of the Prima PLC.

It has been designed with a rotational axis equipped with an encoder to allow the angle positioning of the roller and the usage of special high speed electro-motorized accessories integrated in the tool holder station for executing horizontal or circumferential milling of the rubber or techno-polymer surface.

A new dedicated software allows the milling of horizontal and circumferential lines on the rubber or tecno-polymer coating in various depths and dimensions, and offers a repeatability function for series production; ideal for the printing sector over metallic materials.



EC Norm compliant



mechanical resistance



more productivity



customizable control



compact design



rubber and polymer



management operations

ACCESSORIES

Mole abrasive di precisione

Precision grinding wheels

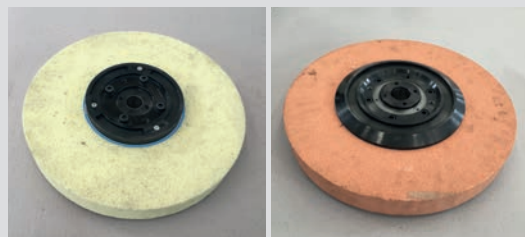

Rossini ha selezionato una serie di mole per rettifica esterna e intestatura a secco e/o con lubrificante di gomme e tecno-polimeri sulla base della sua esperienza produttiva. Contattare il nostro ufficio per ulteriori informazioni in merito.

Rossini selected a range of grinding wheels for external grinding and facing in dry or wet (with lubricant) working conditions for rubber and techno-polymers on the basis of its long term working experience. Contact our office for further info.

ACCESSORIES

Torretta porta utensili a 4 posizioni con blocco e sblocco manuale*4 position tool holder station with manual locking and unlocking system*

Progettata per equipaggiare la macchina con fino a 4 utensili per le diverse operazioni di taglio, diamantatura mola e intestatura.

Designed to equip the Prima Grinder with up to 4 tools for the different cutting, facing or re-work of the grinding wheel.

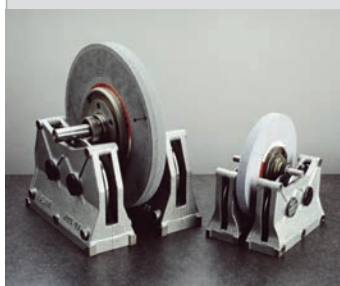
Equilibratrice manuale statica di precisione*Manual static grinding wheels equilibration device*

Strumento indispensabile per una corretta bilanciatura manuale di mole abrasive; attività frequente e necessaria per una corretta esecuzione del lavoro di rettifica. Una solida costruzione abbinata a una progettazione di cuscinetti speciali idonei al particolare impiego fa sì che siano garantite le condizioni ideali per l'operazione di equilibratura. Completano la fornitura un albero per bilanciatura mola e una flangia per mola per macchine Prima.

Instrument needed for a correct manual balancing of the grinding wheels; this is a frequent and needed activity for a proper execution of the grinding process.

A solid design connected to a specific selection of special bearings suitable for this application generate the ideal conditions for the balancing operation. A special shaft with a grinding wheels flange for the Prima Grinder are included with the supply.

Equilibratrice automatica per mole abrasive*Automatic balancing system for grinding wheels*

L'equilibratura dell'assieme mandrino e mola è un'operazione fondamentale per l'ottenimento della richiesta qualità superficiale contribuendo in maniera sostanziale al conseguimento di risultati eccellenti nei processi di rettifica su gomme e tecnopolimeri e per garantire lunga vita ai componenti in rotazione. Il sistema di equilibratura dinamica attivo costantemente durante la lavorazione a montaggio esterno al mandrino è oggi installabile sulle rettificatrici Rossini Prima Grinder anche come applicazione retrofit su macchine esistenti. Per ulteriori informazioni contatta Rossini.

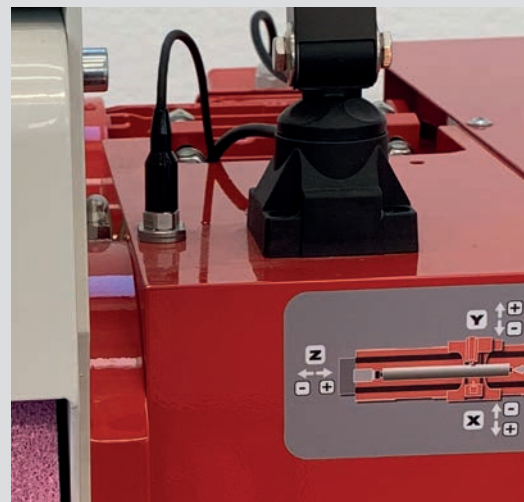

The correct balancing of the shaft and grinding wheel assembly is a basic operation for gaining the right surface quality becoming a milestone to achieve excellent results when grinding rubbers or techno-polymers and to dramatically improve the life of the rotational parts (bearings, shaft, motor and grinding wheel). The dynamic balancing system continuously active during the grinding process and assembled on the external side of the mandrel is now available for the grinding machine of Rossini Prima Grinder also as retrofit application on existing machines. For further info please contact Rossini.

Carrelli porta maniche orizzontali e/o verticali

Horizontal or vertical sleeves trolleys

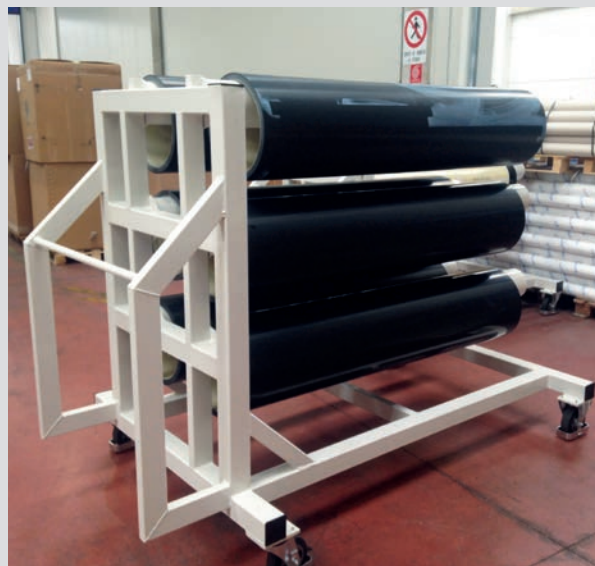

Progettati e realizzati per consentire una corretta movimentazione delle maniche nelle varie fasi produttive dal prelievo da magazzino (vedi anche Storage System Rossini), alla preparazione e montaggio lastra fino all'asservimento alla macchina da stampa; il posizionamento della manica sul carrello è guidato da inserti plastici. Solida struttura in acciaio elettro-saldato, verniciata e personalizzabile a seconda della esigenza del cliente (numero maniche e dimensioni).

Designed and manufactured to allow a correct handling of the sleeves in the different production phases from the pick-up from the storage (see also Storage System Rossini), to the preparation and assembly of the plate up to the installation in the printing machine; the positioning of the sleeve on the trolley is driven by plastic inserts. Solid electro-welded steel structure, painted and customized according the customer's requirements (number of sleeves and sizes).

Carrello porta rulli

Trolley for rubber roller

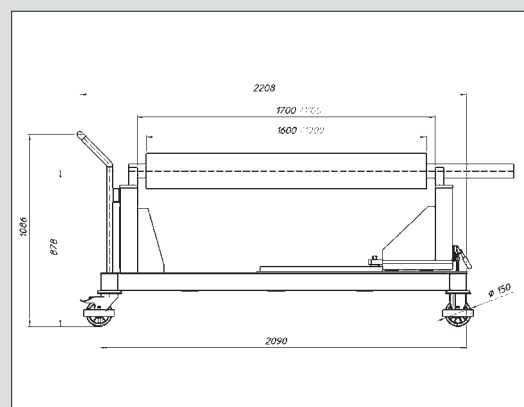

Principalmente pensato per asservimento alla rettifica PRIMA. Consente la movimentazione di due rulli (ad esempio uno in carico e uno in scarico dalla macchina al magazzino e/o al punto di utilizzo) in un range da 1100 a 1700 [mm] di lunghezza regolabile tra i supporti, con un diametro fino a 300 [mm] e un peso massimo trasportabile pari a 400 [kg]. Il carrello può essere impiegato per trasporto di mandrini, alberi, sleeves o anilox. Personalizzabile in funzione delle esigenze cliente.

Mainly designed as ancillary for the PRIMA GRINDER. It allows the handling of two rollers (i.e. one for loading and one in download from the machine to the storage or usage point) in a dimension range from 1100 to 1700 [mm] variable distance between the supports, a diameter up to 300 [mm] and a maximum weight of 400 [kg]. The trolley can be used also to carry mandrels, shafts, sleeves or anilox. It can be designed according customer's request.

Carrello porta mandrini con morsa per cambio maniche

Mandrel holder trolley with clamping device



Progettato per una facile e corretta operazione di cambio maniche Speedwell e/o flexo portalastra sul mandrino di servizio. Il mandrino è bloccato nella morsa manuale grazie a una rotazione di un eccentrico e successivamente collegato al circuito di aria compressa per il montaggio/smontaggio della manica che viene quindi estratta frontalmente. L'attrezzatura è normalmente posizionata in un'area equipaggiata con carro a ponte e/o piantana di carico per il sollevamento del mandrino e il suo posizionamento in morsa.

Designed for an easy and well done Speedwell Sleeve (and/or flexo sleeves) change on the service mandrels. The mandrel is clamped by a manual device through a rotation of an eccentric and later on connected to the compressed air circuit for assembling or dismounting the sleeve that is removed from the front side. This device is normally placed in an area equipped with a crane for elevating the mandrel from the trolley and its positioning in the clamping device.

Sistemi di depolverazione aria

Air filtering systems



Un efficace impianto di aspirazione e successiva filtrazione del particolato generato dalla rettifica è il perfetto abbinamento previsto da Rossini per la rettificatrice Prima Grinder per un'efficiente gestione del processo produttivo e un corretto confort dell'operatore. Rossini ha definito i corretti parametri e la miglior soluzione tecnica dopo una accurata analisi e sulla base della sua esperienza di lungo termine del processo di rettifica su gomme e tecnopolimeri senza trascurare il fattore economico per l'azienda nel rispetto delle normative vigenti. Disponibili differenti configurazioni impianto in base alle esigenze cliente.

An effective air suction system with in-line filtering of the dust generated by the grinding process is the perfect ancillary selected by Rossini for the Prima Grinder to maintain an efficient production process and a correct environmental condition of the operator. Rossini defined the right product parameters and the best technical solution after a deep analysis and its long term direct experience on the grinding process of rubbers and tecno-polymers also taking in the due consideration the economical factor for the customer according to the local laws. Available different system configuration depending on the customer requirements.

Per novità, aggiornamenti e maggiori informazioni sui prodotti e sul mondo

Rossini visitate il sito:

For news, updates and further information on the products and the Rossini world visit the website:

www.rossini-spa.it



La riproduzione anche parziale di questo depliant e del suo contenuto è possibile soltanto con l'autorizzazione scritta della Rossini Spa. Le informazioni contenute nel presente depliant possono subire variazioni pertanto invitiamo il Cliente a rivolgersi sempre alla Rossini Spa al fine di ottenere una completa e aggiornata informazione sulle caratteristiche specifiche dei prodotti qui descritti.

The brochure and its contents may only be reproduced, including partially, with written authorisation from Rossini Spa. The information contained in this brochure may change. Customers should always contact Rossini Spa in order to obtain complete, updated information on the specific characteristics of the products described herein.

Graphic Design

vb-creative.it

All rights reserved®

Printing in Italy

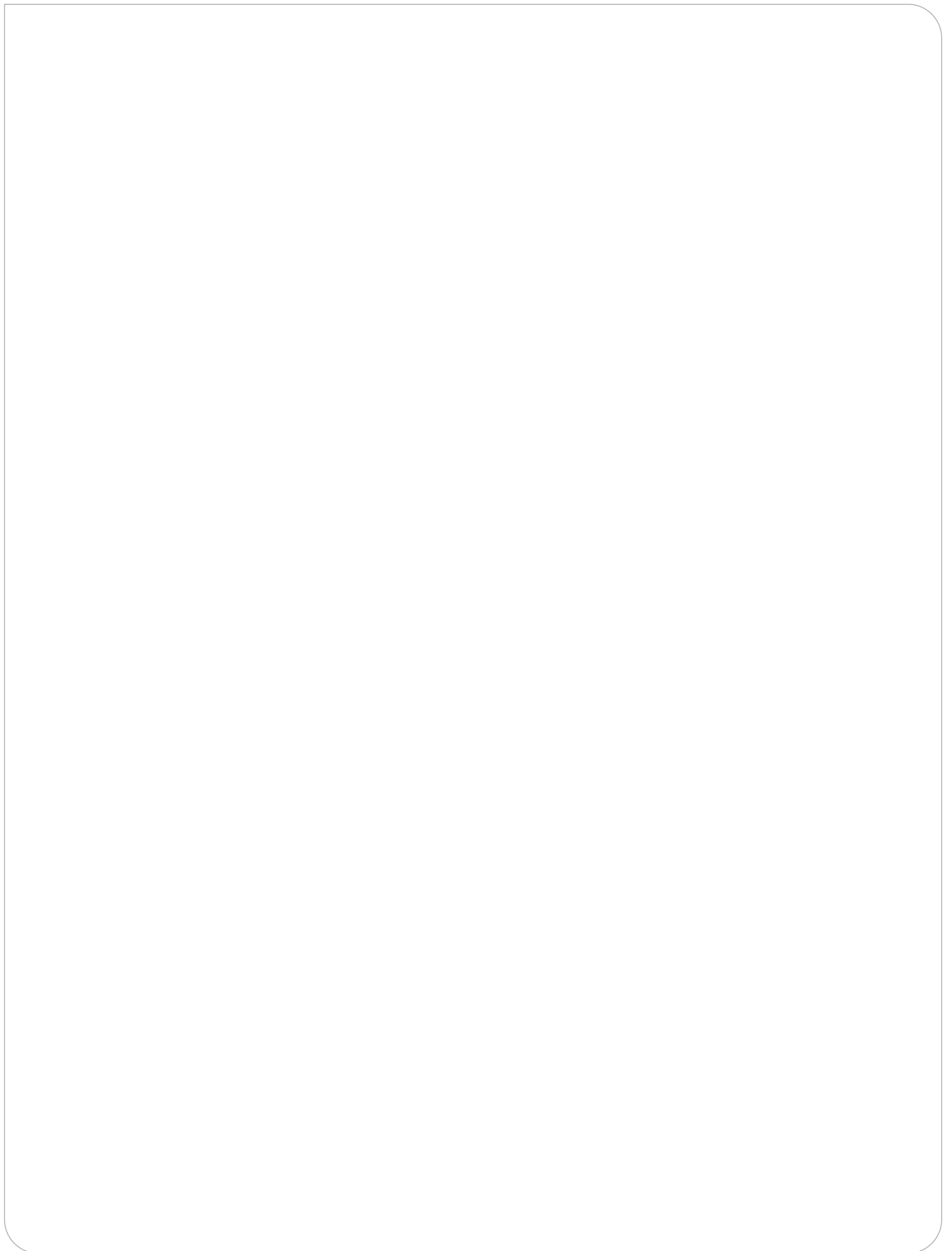



ROSSINI
1928

